

XLamp® CMB1840 LED



PRODUCT DESCRIPTION

The XLamp® CMB family delivers industry-leading lumen density and efficacy in Cree LED’s package and LES sizes. Leveraging the latest COB technology platform, the CMB family provides a no-compromise performance upgrade to existing CXA, CXB and CMA product families while retaining mechanical and optical compatibility with them.

XLamp CMB LEDs are optimized for premium indoor lighting applications, including track, spot and downlight, as well as outdoor lighting.

FEATURES

- 14-mm optical source
- Mechanical and optical design consistent with CXA18, CXB18 and CMA18 LEDs with a 14-mm optical source
- Available in 70, 80, 90, and 95 CRI minimum options
- EasyWhite® 2-, 3- and 5-step binning
- Premium Color 2- and 3-step binning
- Forward voltage option: 36-V class
- 85 °C binning and characterization
- Maximum drive current: 2400 mA
- 115° viewing angle, uniform chromaticity profile
- Top-side solder connections
- RoHS and REACH compliant
- UL® recognized component (E349212)

TABLE OF CONTENTS

| | |
|--|----|
| Characteristics | 2 |
| Operating Limits..... | 2 |
| Flux Characteristics, Order Codes & Bins - Standard LEDs..... | 3 |
| Flux Characteristics, Order Codes & Bins - Standard LEDs, Premium Color..... | 4 |
| Relative Spectral Power Distribution, Standard LEDs..... | 5 |
| Relative Spectral Power Distribution, Premium Color LEDs..... | 6 |
| Electrical Characteristics..... | 8 |
| Relative Luminous Flux..... | 9 |
| Typical Spatial Distribution..... | 9 |
| Performance Groups - Chromaticity | 10 |
| Premium Color Performance Groups - Chromaticity | 11 |
| EasyWhite® Bins Plotted on the 1931 CIE Color Space | 12 |
| Premium Color Bins Plotted on the 1931 CIE Color Space..... | 13 |
| Bin and Order Code Formats..... | 15 |
| Mechanical Dimensions | 16 |
| Thermal Design | 17 |
| Notes | 18 |
| Packaging..... | 19 |



Cree LED / 4001 E. Hwy. 54, Suite 2000 / Durham, NC 27709 USA / +1.919.313.5330 / www.cree-led.com

CHARACTERISTICS

| Characteristics | Unit | Minimum | Typical | Maximum |
|---|---------|---------|----------|---------|
| Viewing angle (FWHM) | degrees | | 115 | |
| ESD withstand voltage (JEDEC JS-001-2012) | V | | Class 3A | |
| DC forward current | mA | | | 2400* |
| Reverse current | mA | | | 0.1 |
| Forward voltage (@ 1100 mA, 85 °C) | V | | 34.4 | 38 |

* Refer to the Operating Limits section.

OPERATING LIMITS

The maximum current rating of the CMB1840 LED depends on the case temperature (T_c) when the LED has reached thermal equilibrium under steady-state operation. The graph shown below assumes that the system design employs good thermal management (thermal interface material and heat sink) and may vary when poor thermal management is employed. Either solder pad shown in the Mechanical Dimensions section on page 16 can be used as the T_c measurement point.

Another important factor in good thermal management is the temperature of the Light Emitting Surface (LES). Cree LED recommends a maximum LES temperature of 140 °C to ensure optimal LED lifetime. Please refer to the Thermal Design section on page 17 for more information on LES temperature measurement.

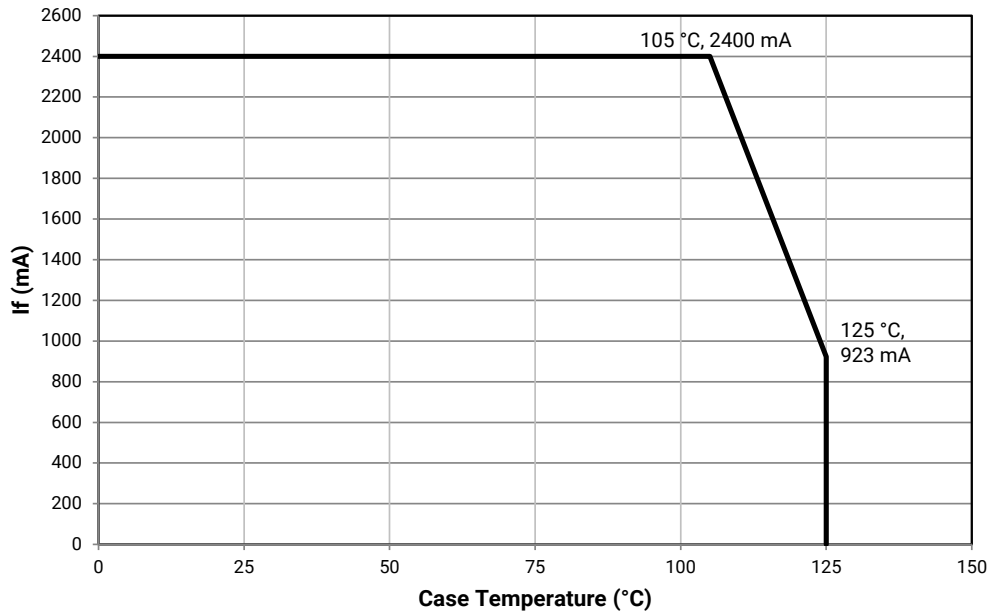

FLUX CHARACTERISTICS, ORDER CODES & BINS - STANDARD LEDS (I_F = 1100 mA, T_J = 85 °C)

The following tables provide order codes for XLamp CMB1840 LEDs. For a complete description of the order code nomenclature, please see the Bin and Order Code Formats section (page 15).

| Nominal CCT | CRI | | Minimum Luminous Flux (lm) | Typical Luminous Flux (lm) | 2-Step | | 3-Step | | 5-Step | |
|-------------|------|-----|----------------------------|----------------------------|--------|--------------------------|--------|--------------------------|--------|--------------------------|
| | Min. | Typ | | | Group | Order Code | Group | Order Code | Group | Order Code |
| 6500 K | 70 | 73 | 6154 | 6601 | | | | | 65E | CMB1840-0000-000N0B0A65E |
| | 80 | 82 | 5610 | 6018 | | | 65G | CMB1840-0000-000N0H0A65G | | |
| 5700 K | 70 | 73 | 6106 | 6549 | | | | | 57E | CMB1840-0000-000N0B0A57E |
| | 80 | 82 | 5567 | 5971 | | | 57G | CMB1840-0000-000N0H0A57G | | |
| | 90 | 92 | 4898 | 5254 | | | 57G | CMB1840-0000-000N0U0A57G | | |
| 5000 K | 70 | 73 | 6106 | 6549 | | | | | 50E | CMB1840-0000-000N0B0A50E |
| | 80 | 82 | 5567 | 5971 | | | 50G | CMB1840-0000-000N0H0A50G | | |
| | 90 | 92 | 4835 | 5186 | | | 50G | CMB1840-0000-000N0U0A50G | | |
| 4000 K | 70 | 73 | 6035 | 6474 | | | | | 40E | CMB1840-0000-000N0B0A40E |
| | 80 | 82 | 5503 | 5903 | 40H | CMB1840-0000-000N0H0A40H | 40G | CMB1840-0000-000N0H0A40G | | |
| | 90 | 92 | 4735 | 5078 | 40H | CMB1840-0000-000N0U0A40H | 40G | CMB1840-0000-000N0U0A40G | | |
| 3500 K | 80 | 82 | 5460 | 5856 | 35H | CMB1840-0000-000N0H0A35H | 35G | CMB1840-0000-000N0H0A35G | | |
| | 90 | 92 | 4730 | 5074 | 35H | CMB1840-0000-000N0U0A35H | 35G | CMB1840-0000-000N0U0A35G | | |
| 3000 K | 70 | 73 | 5879 | 6306 | | | | | 30E | CMB1840-0000-000N0B0A30E |
| | 80 | 82 | 5309 | 5693 | 30H | CMB1840-0000-000N0H0A30H | 30G | CMB1840-0000-000N0H0A30G | | |
| | 90 | 92 | 4664 | 5003 | 30H | CMB1840-0000-000N0U0A30H | 30G | CMB1840-0000-000N0U0A30G | | |
| 2700 K | 80 | 82 | 5147 | 5521 | 27H | CMB1840-0000-000N0H0A27H | 27G | CMB1840-0000-000N0H0A27G | | |
| | 90 | 92 | 4487 | 4813 | 27H | CMB1840-0000-000N0U0A27H | 27G | CMB1840-0000-000N0U0A27G | | |
| 2200 K | 80 | 82 | 4529 | 4858 | | | 22G | CMB1840-0000-000N0H0A22G | | |

- Notes**
- Cree LED maintains a tolerance of ±7% on flux and power measurements, ±0.005 on chromaticity (CCx, CCy) measurements and a tolerance of ±2 on CRI measurements. See the Measurements section (page 18).
 - For 80 CRI minimum LEDs, CRI R9 minimum is 0 with a ±2 tolerance. For 90 CRI minimum LEDs, CRI R9 typical is 60.

FLUX CHARACTERISTICS, ORDER CODES & BINS - STANDARD LEDS, PREMIUM COLOR ($I_f = 1100 \text{ mA}$, $T_j = 85 \text{ °C}$)

Fidelity

| Nominal CCT | CRI* | | Minimum Luminous Flux (lm) | Typical Luminous Flux (lm) | 2-Step | |
|-------------|------|-----|----------------------------|----------------------------|--------|--------------------------|
| | Min. | Typ | | | Group | Order Code |
| 4000 K | 95 | 98 | 4278 | 4588 | 40H | CMB1840-0000-000N0Z0A40H |
| 3500 K | 95 | 98 | 4255 | 4564 | 35H | CMB1840-0000-000N0Z0A35H |
| 3000 K | 95 | 98 | 4131 | 4431 | 30H | CMB1840-0000-000N0Z0A30H |
| 2700 K | 95 | 98 | 3933 | 4218 | 27H | CMB1840-0000-000N0Z0A27H |

Specialty

| Nominal CCT | CRI | | Minimum Luminous Flux (lm) | Typical Luminous Flux (lm) | 2-Step | | 3-Step | | | |
|-------------|------|-----|----------------------------|----------------------------|--------|--------------------------|--------|--------------------------|-------|--------------------------|
| | Min. | Typ | | | Group | Order Code | Group | Order Code | Group | Order Code |
| 3100 K | 90 | 92 | 4454 | 4778 | | | 31Q | CMB1840-0000-000N0U0A31Q | | |
| 3000 K | 90 | 92 | 4384 | 4703 | | | | | 30U | CMB1840-0000-000N0U0A30U |
| | 90 | 92 | 4571 | 4903 | | | 30Q | CMB1840-0000-000N0U0A30Q | | |
| | 95 | 98 | 3893 | 4175 | L7C | CMB1840-0000-000N0Z0AL7C | | | | |

- Notes**
- Cree LED maintains a tolerance of $\pm 7\%$ on flux and power measurements, ± 0.005 on chromaticity (CCx, CCy) measurements and a tolerance of ± 2 on CRI measurements. See the Measurements section (page 18).
 - For 80 CRI minimum LEDs, CRI R9 minimum is 0 with a ± 2 tolerance. For 90 CRI minimum LEDs, CRI R9 typical is 60.

RELATIVE SPECTRAL POWER DISTRIBUTION, STANDARD LEDs

The following graphs are the result of a series of pulsed measurements at 1100 mA and $T_j = 85^\circ\text{C}$.

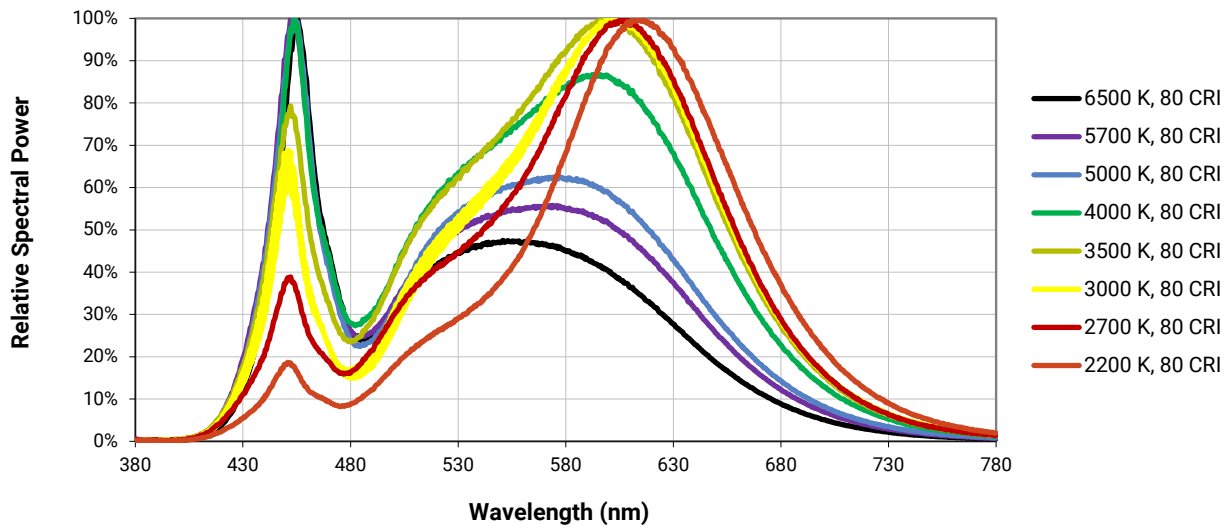
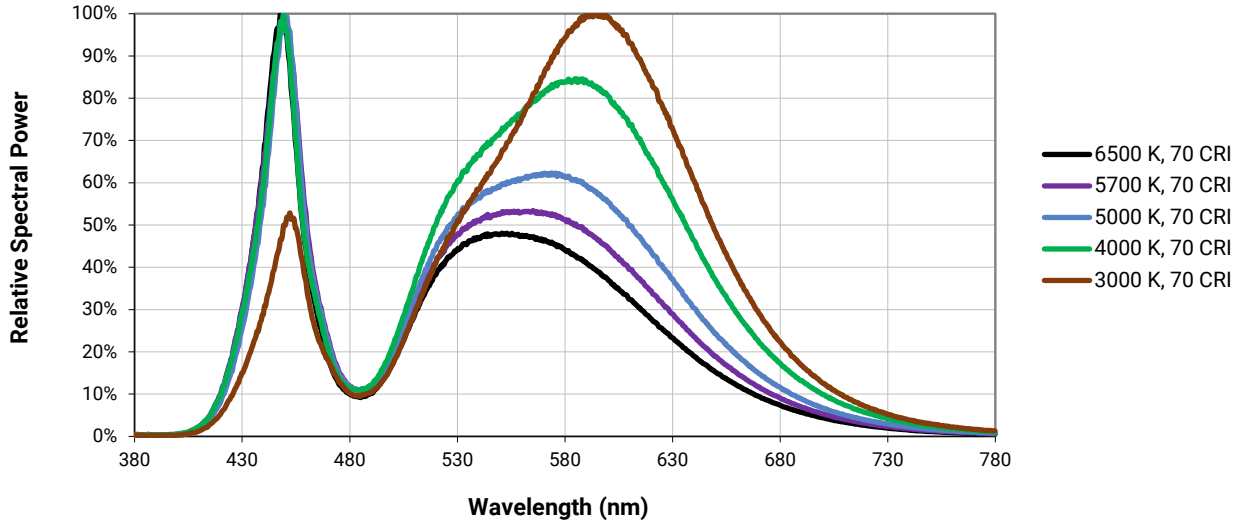

RELATIVE SPECTRAL POWER DISTRIBUTION, STANDARD LEDS - CONTINUED

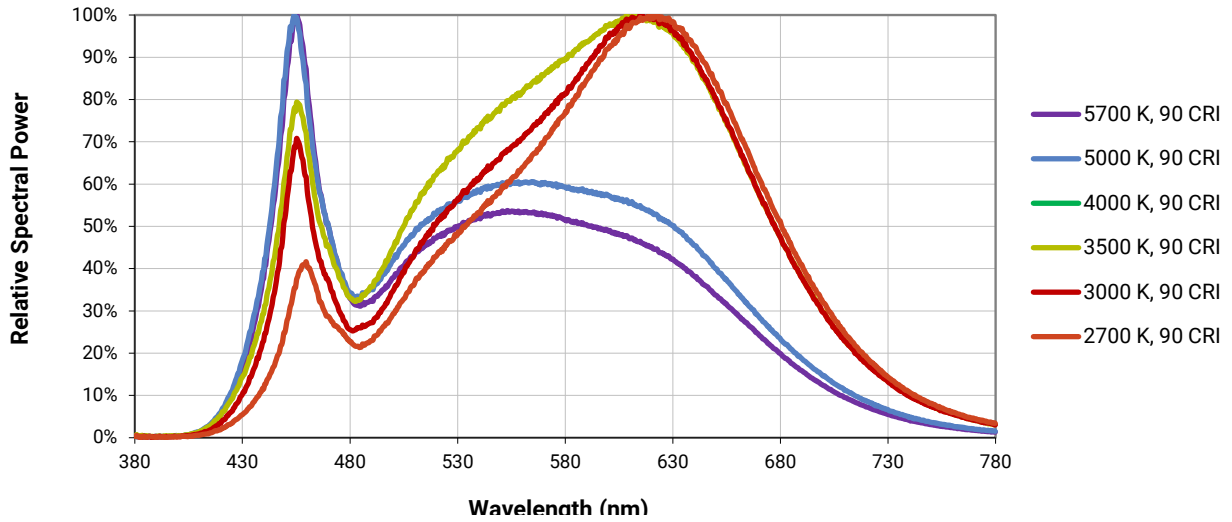

RELATIVE SPECTRAL POWER DISTRIBUTION, PREMIUM COLOR LEDS

The following graphs are the result of a series of pulsed measurements at 1100 mA and $T_j = 85^\circ\text{C}$.

Fidelity

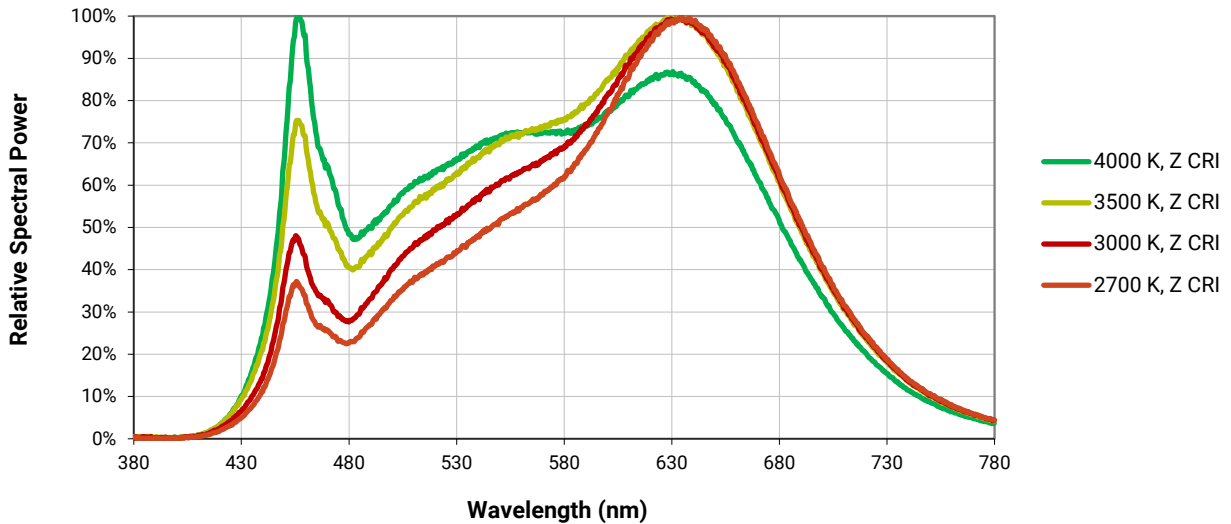

RELATIVE SPECTRAL POWER DISTRIBUTION, PREMIUM COLOR LEDS - CONTINUED

Specialty

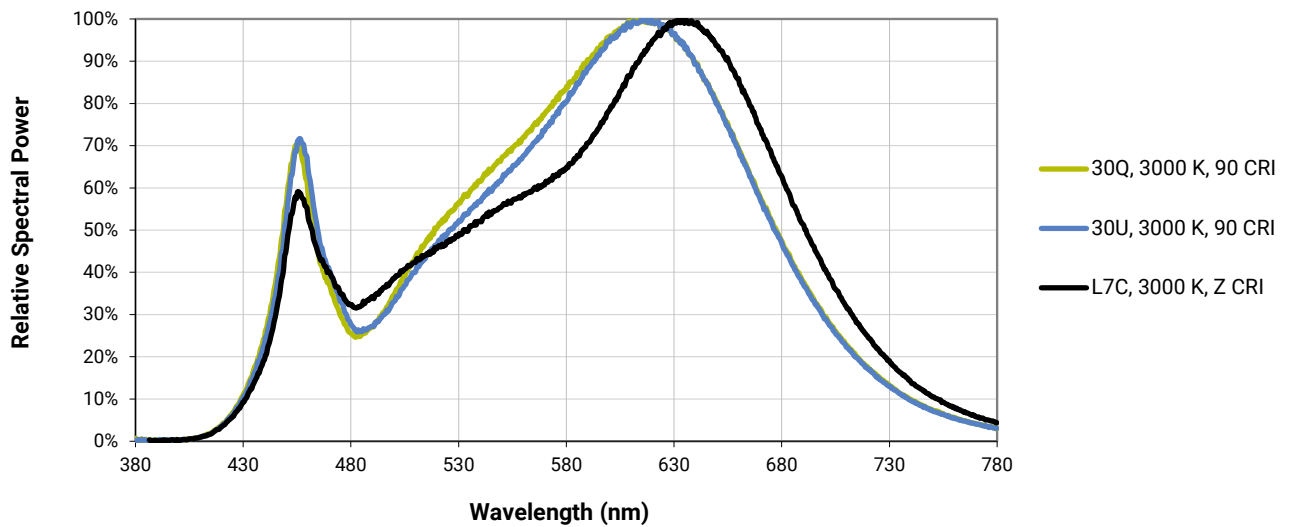
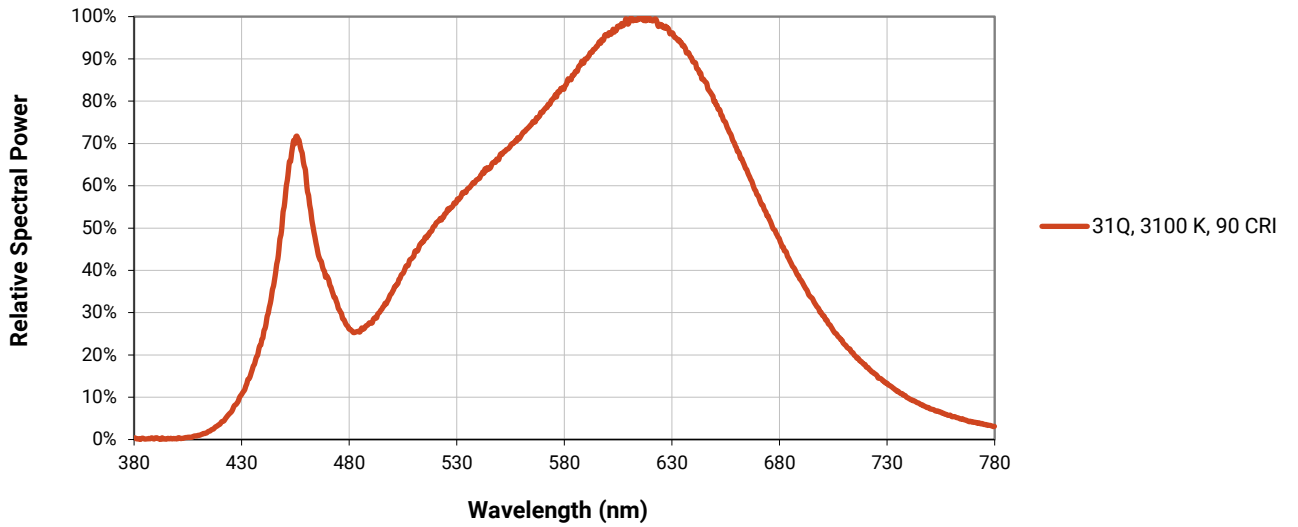

ELECTRICAL CHARACTERISTICS

The following graph is the result of a series of steady-state measurements.

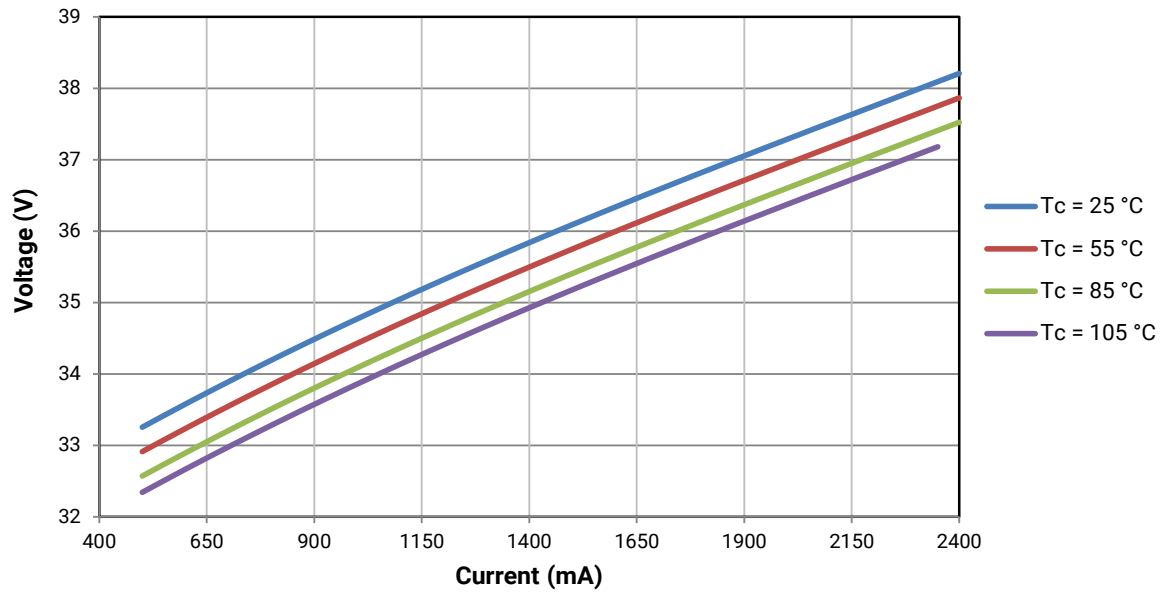

RELATIVE LUMINOUS FLUX

The relative luminous flux values provided below are the ratio of measurements of the CMB1840 LED at steady-state operation at the given conditions, divided by the flux measured during binning, which is a pulsed measurement at 1100 mA at $T_j = 85^\circ\text{C}$.

For example, at steady-state operation of $T_c = 55^\circ\text{C}$, $I_f = 1400\text{ mA}$, the relative luminous flux ratio is 125% in the chart below. A CMB1840 LED that measures 6430 lm during binning will deliver 8038 lm (6430×1.25) at steady-state operation of $T_c = 55^\circ\text{C}$, $I_f = 1400\text{ mA}$.

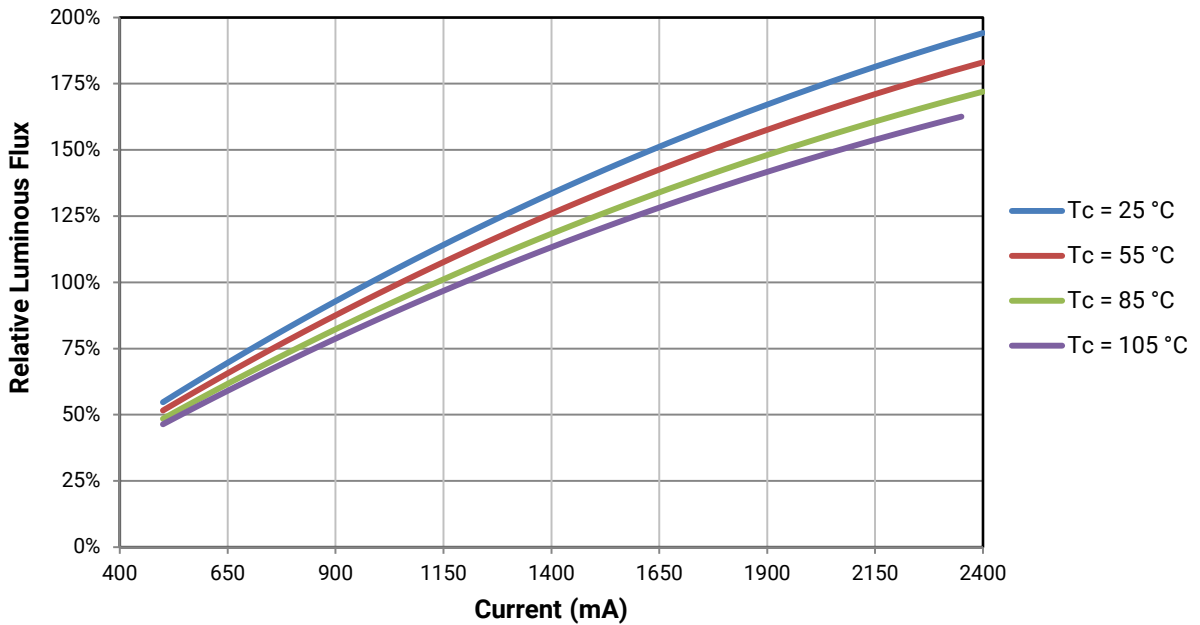

TYPICAL SPATIAL DISTRIBUTION

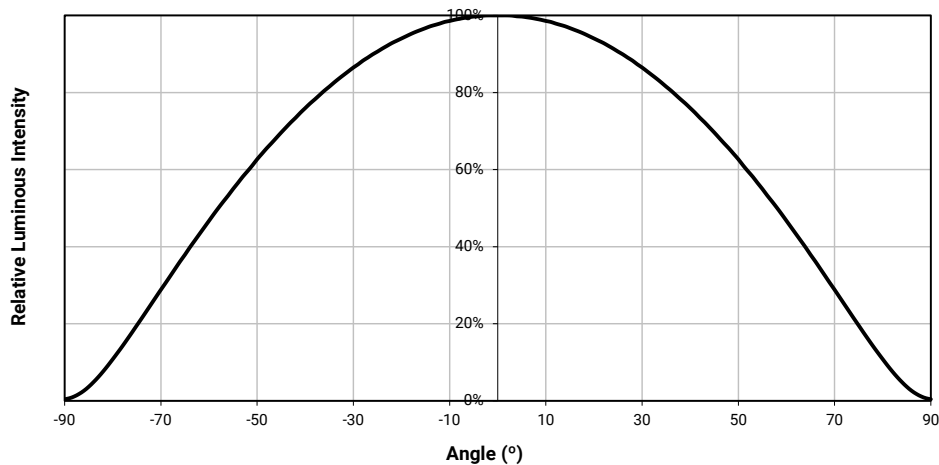

PERFORMANCE GROUPS - CHROMATICITY ($T_j = 85\text{ °C}$)

XLamp CMB1840 LEDs are tested for chromaticity and placed into one of the regions defined by the following bounding coordinates.

| EasyWhite Color Temperatures – 2-Step | | | |
|---------------------------------------|--------|--------|--------|
| Code | CCT | x | y |
| 40H | 4000 K | 0.3764 | 0.3711 |
| | | 0.3784 | 0.3787 |
| | | 0.3847 | 0.3826 |
| | | 0.3825 | 0.3748 |
| 35H | 3500 K | 0.4022 | 0.3858 |
| | | 0.4053 | 0.3942 |
| | | 0.4125 | 0.3977 |
| | | 0.4091 | 0.3891 |
| 30H | 3000 K | 0.4287 | 0.3975 |
| | | 0.4328 | 0.4064 |
| | | 0.4390 | 0.4086 |
| | | 0.4347 | 0.3996 |
| 27H | 2700 K | 0.4524 | 0.4048 |
| | | 0.4574 | 0.4140 |
| | | 0.4633 | 0.4154 |
| | | 0.4581 | 0.4062 |

| EasyWhite Color Temperatures – 3-Step Ellipse | | | | | | |
|---|--------|--------------|--------|------------|------------|--------------------|
| Bin Code | CCT | Center Point | | Major Axis | Minor Axis | Rotation Angle (°) |
| | | x | y | a | b | |
| 65G | 6500 K | 0.3123 | 0.3282 | 0.00666 | 0.00330 | 61.0 |
| 57G | 5700 K | 0.3287 | 0.3417 | 0.00738 | 0.00360 | 72.0 |
| 50G | 5000 K | 0.3447 | 0.3553 | 0.00840 | 0.00312 | 65.0 |
| 40G | 4000 K | 0.3818 | 0.3797 | 0.00939 | 0.00402 | 53.7 |
| 35G | 3500 K | 0.4073 | 0.3917 | 0.00927 | 0.00414 | 54.0 |
| 30G | 3000 K | 0.4338 | 0.4030 | 0.00834 | 0.00408 | 53.2 |
| 27G | 2700 K | 0.4577 | 0.4099 | 0.00834 | 0.00420 | 48.5 |
| 22G | 2200 K | 0.5066 | 0.4158 | 0.00980 | 0.00480 | 45.5 |

| EasyWhite Color Temperatures – 5-Step Ellipse | | | | | | |
|---|--------|--------------|--------|------------|------------|--------------------|
| Bin Code | CCT | Center Point | | Major Axis | Minor Axis | Rotation Angle (°) |
| | | x | y | a | b | |
| 65E | 6500 K | 0.3123 | 0.3282 | 0.01110 | 0.00550 | 61.0 |
| 57E | 5700 K | 0.3287 | 0.3417 | 0.01230 | 0.00600 | 72.0 |
| 50E | 5000 K | 0.3447 | 0.3553 | 0.01400 | 0.00520 | 65.0 |
| 40E | 4000 K | 0.3818 | 0.3797 | 0.01565 | 0.00670 | 53.7 |
| 30E | 3000 K | 0.4338 | 0.4030 | 0.01390 | 0.00680 | 53.2 |

PREMIUM COLOR PERFORMANCE GROUPS - CHROMATICITY ($T_j = 85\text{ }^\circ\text{C}$)

XLamp CMB1840 LEDs are tested for chromaticity and placed into one of the regions defined by the following bounding coordinates.

Fidelity

| EasyWhite Color Temperatures – 2-Step | | | |
|---------------------------------------|--------|--------|--------|
| Code | CCT | x | y |
| 40H | 4000 K | 0.3764 | 0.3711 |
| | | 0.3784 | 0.3787 |
| | | 0.3847 | 0.3826 |
| | | 0.3825 | 0.3748 |
| 35H | 3500 K | 0.4022 | 0.3858 |
| | | 0.4053 | 0.3942 |
| | | 0.4125 | 0.3977 |
| | | 0.4091 | 0.3891 |
| 30H | 3000 K | 0.4287 | 0.3975 |
| | | 0.4328 | 0.4064 |
| | | 0.4390 | 0.4086 |
| | | 0.4347 | 0.3996 |
| 27H | 2700 K | 0.4524 | 0.4048 |
| | | 0.4574 | 0.4140 |
| | | 0.4633 | 0.4154 |
| | | 0.4581 | 0.4062 |

Specialty

| EasyWhite Color Temperatures – 2-Step | | | |
|---------------------------------------|--------|--------|--------|
| Code | CCT | x | y |
| L7C | 3000 K | 0.4192 | 0.3754 |
| | | 0.4224 | 0.3823 |
| | | 0.4291 | 0.3847 |
| | | 0.4257 | 0.3777 |

| EasyWhite Color Temperatures – 3-Step Ellipse | | | | | | |
|---|--------|--------------|--------|------------|------------|--------------------|
| Bin Code | CCT | Center Point | | Major Axis | Minor Axis | Rotation Angle (°) |
| | | x | y | a | b | |
| 31Q | 3100 K | 0.4236 | 0.3888 | 0.00848 | 0.00455 | 50.3 |
| 30Q | 3000 K | 0.4305 | 0.3935 | 0.00834 | 0.00408 | 53.2 |
| 30U | 3000 K | 0.4274 | 0.3837 | 0.00834 | 0.00408 | 53.2 |

EASYWHITE® BINS PLOTTED ON THE 1931 CIE COLOR SPACE ($T_j = 85\text{ }^\circ\text{C}$)

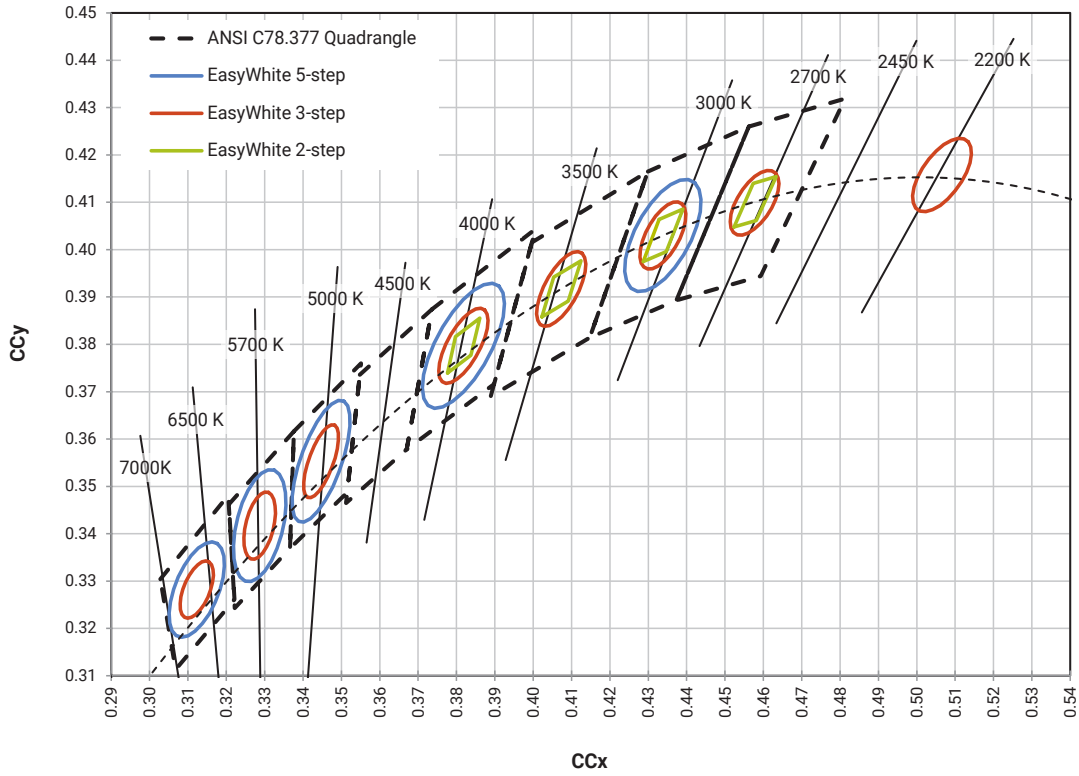

PREMIUM COLOR BINS PLOTTED ON THE 1931 CIE COLOR SPACE ($T_j = 85\text{ }^\circ\text{C}$)

Fidelity (2-step)

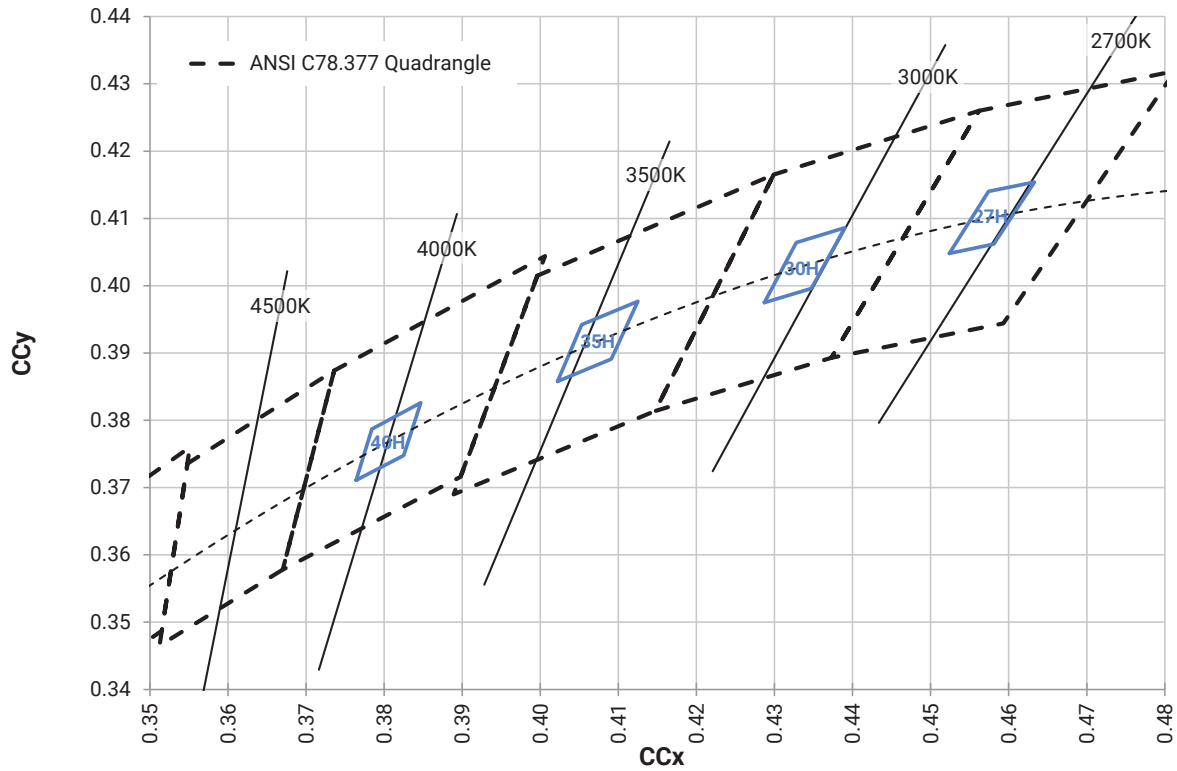

PREMIUM COLOR BINS PLOTTED ON THE 1931 CIE COLOR SPACE ($T_j = 85\text{ }^\circ\text{C}$) - CONTINUED

Speciality (2-step)

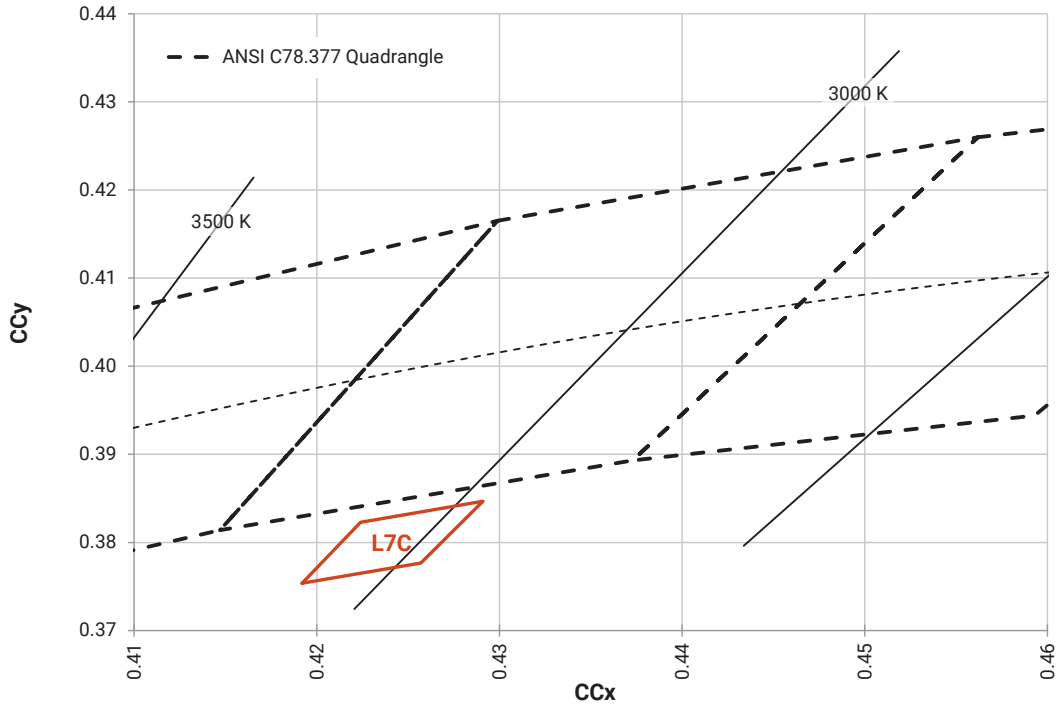

Speciality (3-step)

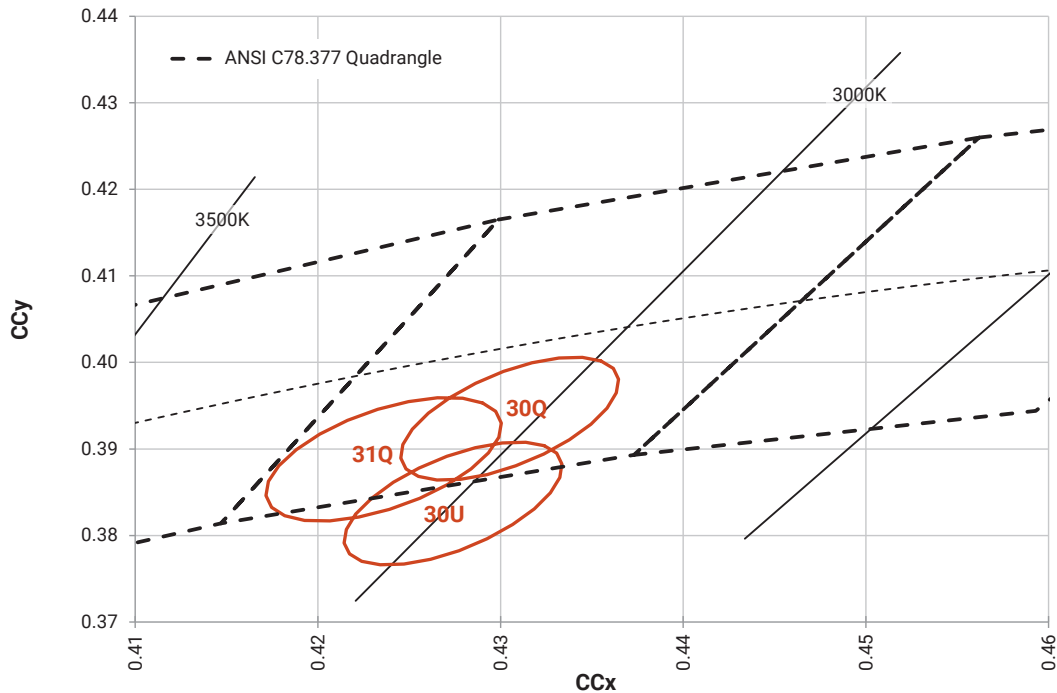

BIN AND ORDER CODE FORMATS

Bin codes and order codes are configured as follows:

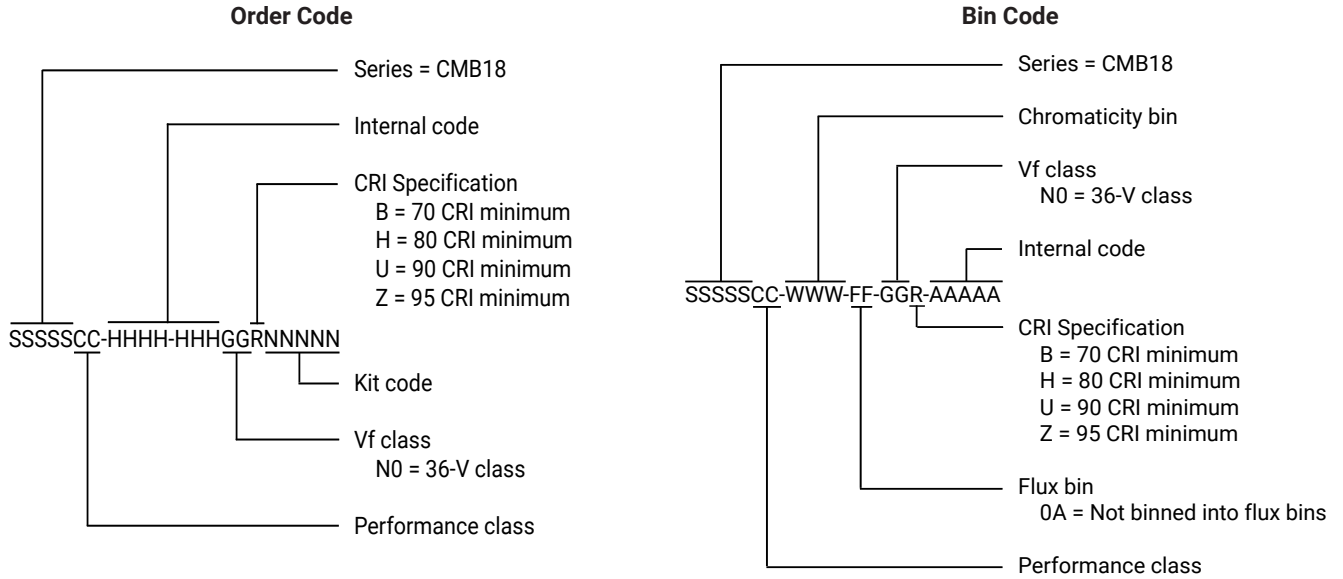

MECHANICAL DIMENSIONS

Dimensions are in mm.

Tolerances unless otherwise specified: $\pm .13$

$x^\circ \pm 1^\circ$

Meaning of LED marking

B1840N = 36-V CMB1840

X₁ X₂ X₃ X₄ X₅

- X1 CCT
 - 1 = 6500 K
 - 2 = 5700 K
 - 3 = 5000 K
 - 5 = 4000 K
 - 6 = 3500 K
 - 7 = 3000 K
 - 8 = 2700 K
 - A = 2200 K

- X2
 - M = EasyWhite or Fidelity LED on the black-body line
 - Q = Specialty LED below the black-body line
 - U = Specialty LED below the black-body line
- X3 X4 Flux bin
 - 0A = Not binned into flux bins
- X5 CRI
 - B = 70 CRI min
 - H = 80 CRI min
 - U = 90 CRI min
 - Z = 95 CRI min

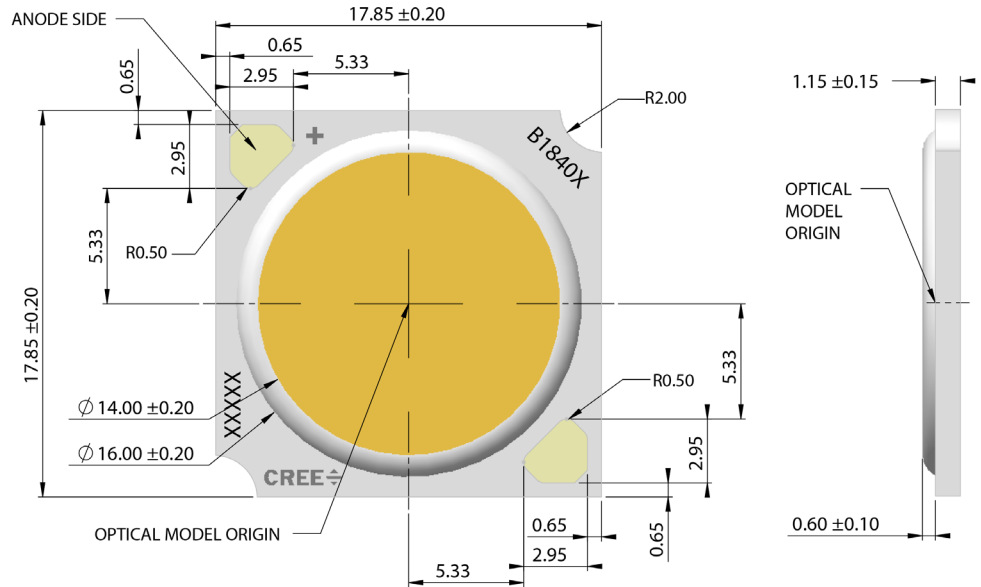

To assist in identifying the LED, CMB1840 LEDs provide a 2D barcode, positioned on the back of the LED, as shown in the following diagram. For a complete description of the bar code format, please refer to the [XLamp CM Family LEDs soldering and handling document](#).

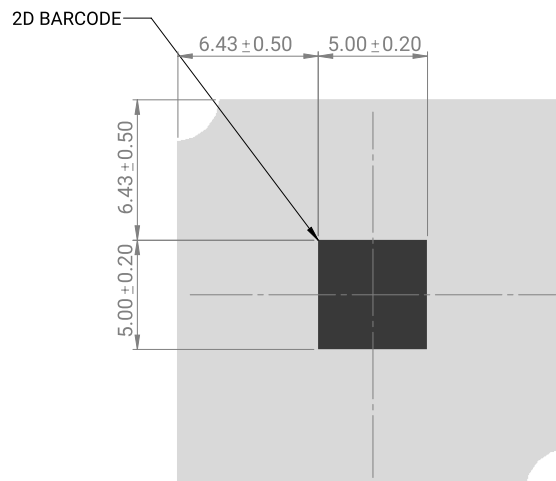

Tc measurement point: either the anode or cathode solder pad

THERMAL DESIGN

The CMB family of LED arrays can include over a hundred different LED die inside one package, and thus over a hundred different junction temperatures (T_j). Cree LED has intentionally removed junction-temperature-based operating limits and replaced the commonplace maximum T_j calculations with maximum ratings based on forward current (I_f) and case temperature (T_c). No additional calculations are required to ensure that the CMB LED is being operated within its designed limits. LES temperature measurement provides additional verification of good thermal design. Please refer to page 2 for the Operating Limit specifications.

There is no need to calculate for T_j inside the package, as the thermal management design process, specifically from solder point (T_{sp}) to ambient (T_a), remains identical to any other LED component. For more information on thermal management of XLamp LEDs, please refer to the [Thermal Management application note](#). For CMB soldering recommendations and more information on thermal interface materials (TIM), LES temperature measurement, and connection methods, please refer to the [XLamp CM Family LEDs soldering and handling document](#).

To keep the CMB1840 LED at or below the maximum rated T_c , the case to ambient temperature thermal resistance (R_{c-a}) must be at or below the maximum R_{c-a} value shown on the following graph, depending on the operating environment. The y-axis in the graph is a base 10 logarithmic scale.

As the figure at right shows, the R_{c-a} value is the sum of the thermal resistance of the TIM (R_{tim}) plus the thermal resistance of the heat sink (R_{hs}).

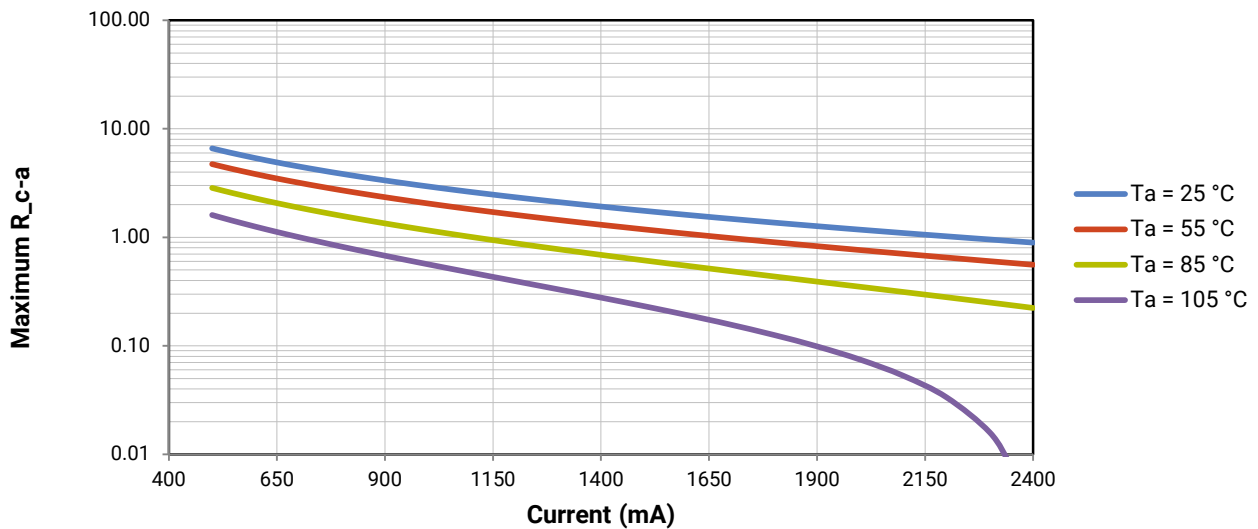
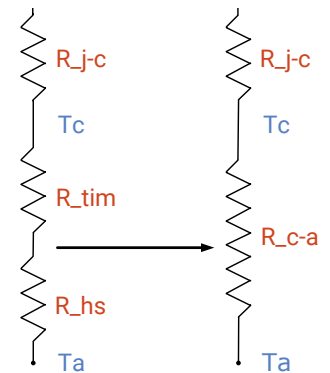

NOTES

Measurements

The luminous flux, radiant power, chromaticity, forward voltage and CRI measurements in this document are binning specifications only and solely represent product measurements as of the date of shipment. These measurements will change over time based on a number of factors that are not within Cree LED's control and are not intended or provided as operational specifications for the products. Calculated values are provided for informational purposes only and are not intended or provided as specifications.

Pre-Release Qualification Testing

Please read the [LED Reliability Overview](#) for details of the qualification process Cree LED applies to ensure long-term reliability for XLamp LEDs and details of Cree LED's pre-release qualification testing for XLamp LEDs. Cree LED did not perform Room Temperature Operating Life (RTOL) testing on the CMB1840 LED.

Lumen Maintenance

Cree LED now uses standardized IES LM-80-08 and TM-21-11 methods for collecting long-term data and extrapolating LED lumen maintenance. For information on the specific LM-80 data sets available for this LED, refer to the public [LM-80 results document](#).

Please read the [Long-Term Lumen Maintenance application note](#) for more details on Cree LED's lumen maintenance testing and forecasting. Please read the [Thermal Management application note](#) for details on how thermal design, ambient temperature, and drive current affect the LED junction temperature.

RoHS Compliance

The levels of RoHS restricted materials in this product are below the maximum concentration values (also referred to as the threshold limits) permitted for such substances, or are used in an exempted application, in accordance with EU Directive 2011/65/EC (RoHS2), as implemented January 2, 2013. RoHS Declarations for this product can be obtained from your Cree LED representative or from the [Product Ecology](#) section of the Cree LED website.

REACH Compliance

REACH substances of very high concern (SVHCs) information is available for this product. Since the European Chemical Agency (ECHA) has published notice of their intent to frequently revise the SVHC listing for the foreseeable future, please contact a Cree LED representative to insure you get the most up-to-date REACH SVHC Declaration. REACH banned substance information (REACH Article 67) is also available upon request.

UL® Recognized Component

This product meets the requirements to be considered a UL Recognized Component with Level 4 enclosure consideration. The LED package or a portion thereof has been investigated as a fire and electrical enclosure per ANSI/UL 8750.

Vision Advisory

WARNING: Do not look at an exposed lamp in operation. Eye injury can result. For more information about LEDs and eye safety, please refer to the [LED Eye Safety application note](#).

PACKAGING

CMB1840 LEDs are packaged in trays of 48. Five trays are sealed in an anti-static bag and placed inside an inner box, for a total of 240 LEDs per box. Each box contains LEDs from the same performance bin. Eight boxes are placed inside a carton, for a total of 1,920 LEDs per carton.

Dimensions are in mm.
Tolerance: ±.5

Load Tray

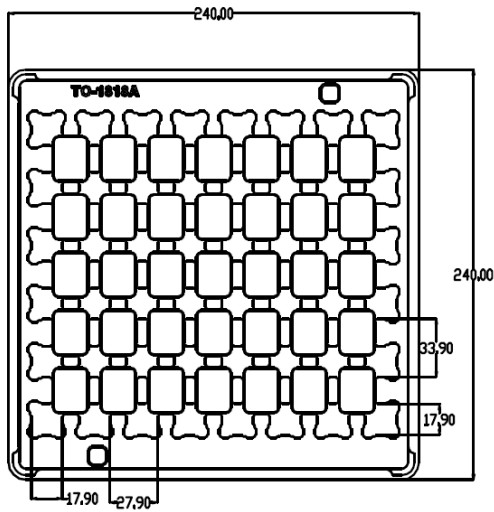

Upper Tray

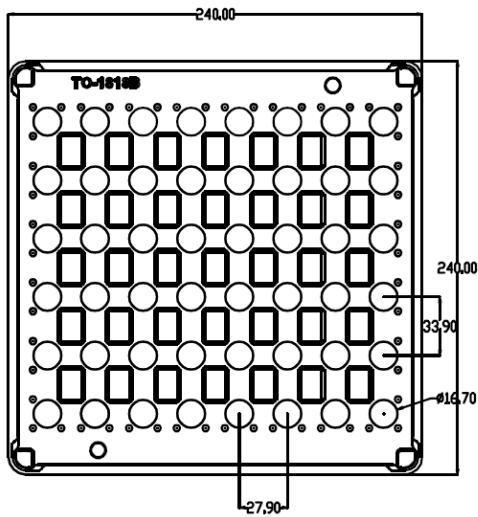

PACKAGING - CONTINUED

CMB1840 LEDs are packaged in trays of 48. Five trays are sealed in an anti-static bag and placed inside an inner box, for a total of 240 LEDs per box. Each box contains LEDs from the same performance bin. Eight boxes are placed inside a carton, for a total of 1,920 LEDs per carton.

Dimensions are in mm.
Tolerance: ± 3 mm

Inner Box

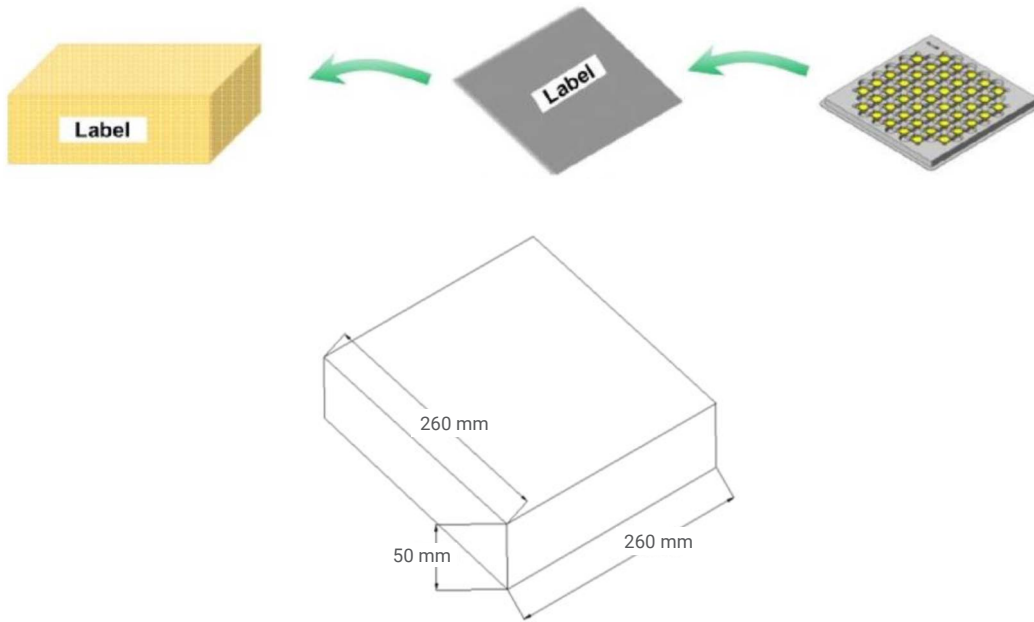

Outer Carton

