

J Series® JB3030C 3-V E & F Class Pro9™ LEDs



PRODUCT DESCRIPTION

J Series® 3030 LEDs are optimized to deliver the best value with high efficacy to low-density, indoor lighting applications, such as downlights, troffers, and panel lights. Pro9™ version LEDs deliver up to 15% higher efficacy for 90 CRI over standard version LEDs without sacrificing color rendering quality. Pro9 LEDs feature the same maximum current plus the same mechanical and electrical characteristics as the standard versions.

FEATURES

- Industry-compatible size : 3.0 x 3.0 x 0.75 mm
- 3-V configurations
- Flux and chromaticity binned at 25 °C
- 6500 K–2700 K ANSI CCTs available
- Pro9 LEDs available in 80 and 90 CRI options
- RoHS compliant
- REACH compliant
- UL® recognized component (E495478)

PRODUCT SUMMARY

Product	Power Class	Test Temperature	Test Current	Typical Forward Voltage	4000 K, 80 CRI		4000 K, 90 CRI		Maximum Current
					Typical Flux	Typical Efficacy	Typical Flux	Typical Efficacy	
JB3030C 3-V E Class Pro9	0.2 W	25 °C	55 mA	2.66 V	34.2 lm	234 lm	31.2 lm	213 LPW	240 mA
JB3030C 3-V F Class Pro9	0.2 W	25 °C	55 mA	2.67 V	33.9 lm	231 lm	30.6 lm	208 LPW	240 mA



J Series® Products are sold exclusively by Cree Venture LED Company Limited (“Cree Venture”), regardless of geography. Any orders for J Series Products that are submitted to Cree LED or any of its other subsidiaries will be directed to Cree Venture for acknowledgment and order fulfillment.

Cree LED / 4001 E. Hwy. 54, Suite 2000 / Durham, NC 27709 USA / +1.919.313.5330 / www.cree-led.com

TABLE OF CONTENTS

Order Code & Bin Code Formats	3
Characteristics	4
Operating Limits.....	5
Flux Characteristics, Order Codes and Bins – JB3030C 3-V E Class Pro9	6
Flux Characteristics, Order Codes and Bins – JB3030C 3-V F Class Pro9	7
Relative Luminous Flux vs. Current.....	8
Electrical Characteristics.....	9
Relative Chromaticity vs. Current.....	10
Relative Chromaticity vs. Junction Temperature	11
Relative Spectral Power Distribution	12
Relative Luminous Flux vs. Junction Temperature	13
Typical Spatial Distribution.....	14
Performance Groups - Luminous Flux.....	15
Performance Groups - Forward Voltage.....	15
Performance Groups - Chromaticity.....	16
Reflow Soldering Characteristics.....	24
Notes	25
Mechanical Dimensions	27
Tape & Reel.....	29
Packaging.....	30

ORDER CODE & BIN CODE FORMATS

Order codes and bin codes for J Series JB3030C 3-V E & F Class LEDs are configured in the following manner:

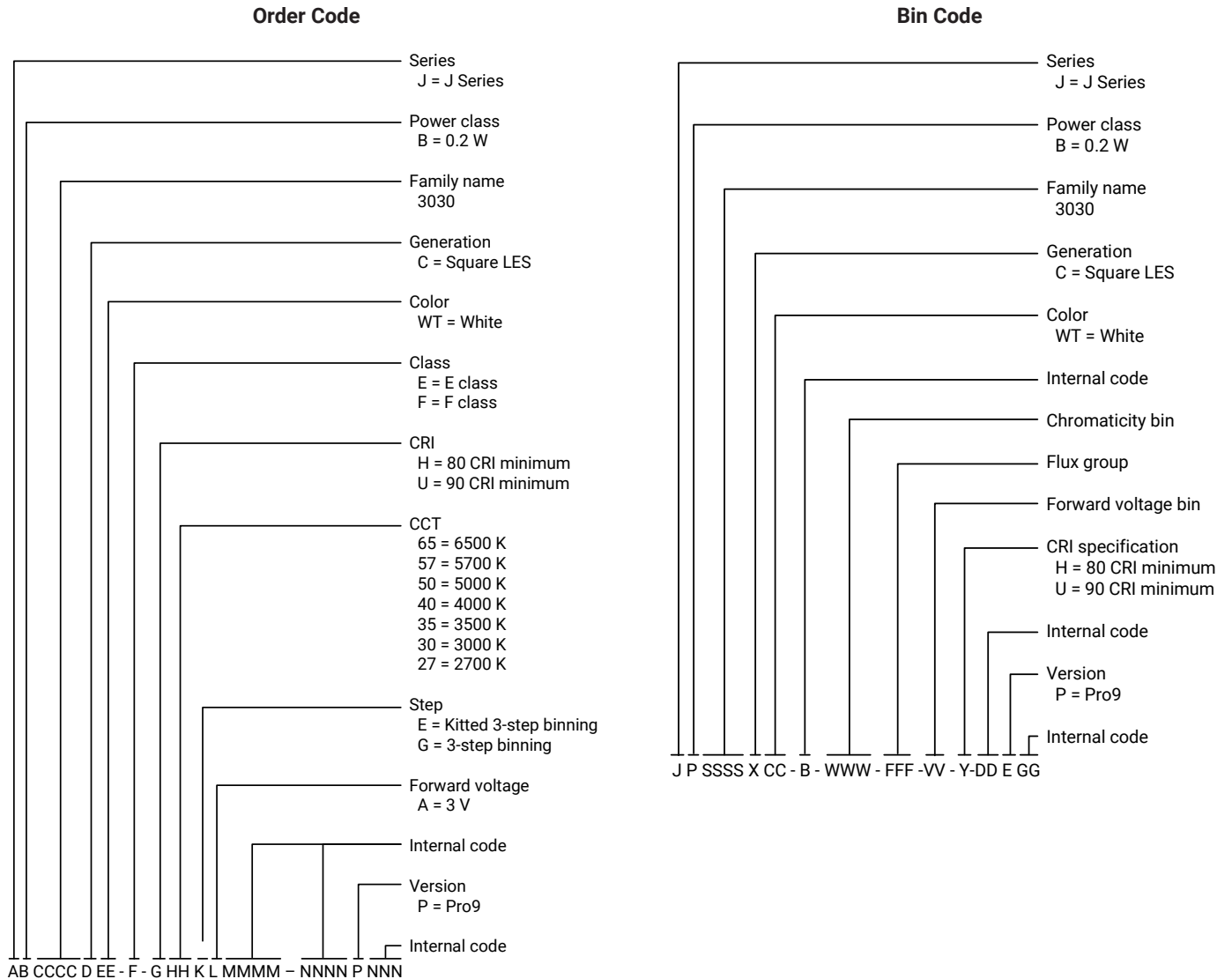

CHARACTERISTICS

E Class

Characteristics	Unit	Minimum	Typical	Maximum
Thermal resistance, junction to solder point \diamond	°C/W		4	
Viewing angle (FWHM)	degrees		116	
Temperature coefficient of voltage	mV/°C		-1.2	
ESD withstand voltage (HBM per MIL-STD-883L)			Class 3B	
DC forward current	mA			240
Reverse voltage	V			5
Forward voltage (@ 55 mA, 25 °C)	V		2.66	2.8
LED junction temperature	°C			125
Operating temperature	°C	-40		105

Notes

- \diamond Thermal resistance measurement was performed per the JEDEC JESD51-14 standard. See the [Thermal Resistance Measurement application note](#) for more details.
- Continuous reverse voltage can cause LED damage.

F Class

Characteristics	Unit	Minimum	Typical	Maximum
Thermal resistance, junction to solder point \diamond	°C/W		4	
Viewing angle (FWHM)	degrees		116	
Temperature coefficient of voltage	mV/°C		-1.2	
ESD withstand voltage (HBM per MIL-STD-883L)			Class 3B	
DC forward current	mA			240
Reverse voltage	V			5
Forward voltage (@ 55 mA, 25 °C)	V		2.67	2.8
LED junction temperature	°C			125
Operating temperature	°C	-40		105

Notes

- \diamond Thermal resistance measurement was performed per the JEDEC JESD51-14 standard. See the [Thermal Resistance Measurement application note](#) for more details.
- Continuous reverse voltage can cause LED damage.

OPERATING LIMITS

The maximum forward current is determined by the thermal resistance between the LED junction and ambient.

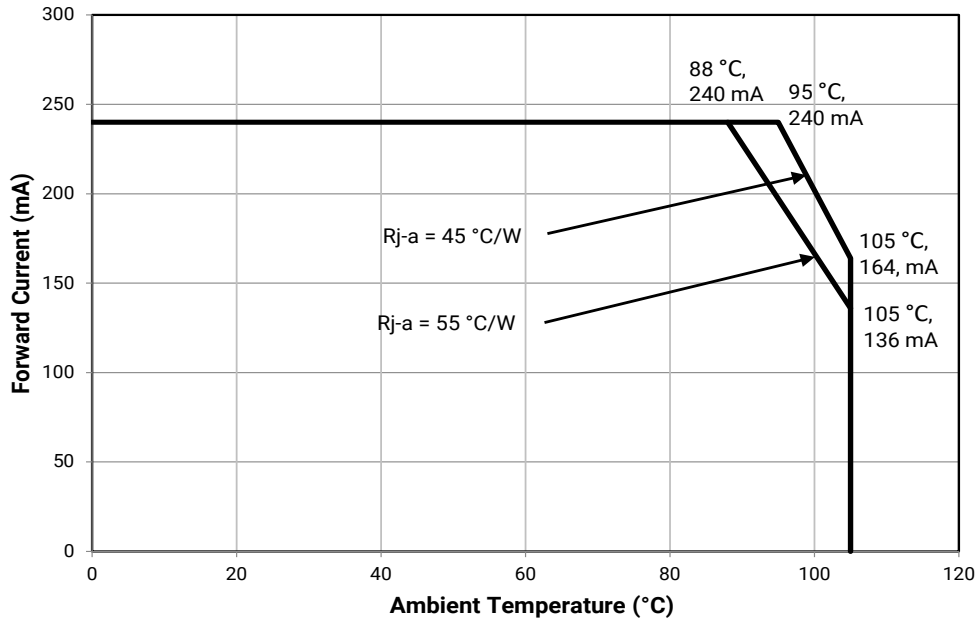

FLUX CHARACTERISTICS, ORDER CODES AND BINS – JB3030C 3-V E CLASS PRO9 (I_F = 55 mA, T_J = 25 °C)

E Class

The following table provides order codes for J Series JB3030C 3-V E Class Pro9 LEDs. For a complete description of the order code nomenclature, please see the Order Code and Bin Code Formats section (page 3). For definitions of the chromaticity kits, please see the Performance Groups - Chromaticity section (page 16).

CCT	Minimum CRI	Minimum Flux	Typical Flux (lm) @ 25 °C	Typical Flux (lm) @ 85 °C*	Kitted 3-Step Order Code	3-Step Order Code
6500 K	80	31	33.4	30.8	JB3030CWT-E-H65EA0000-NZ00P001	JB3030CWT-E-H65GA0000-NZ00P001
	90	29	31	28.5	JB3030CWT-E-U65EA0000-NZ00P001	JB3030CWT-E-U65GA0000-NZ00P001
5700 K	80	31	33.6	30.9	JB3030CWT-E-H57EA0000-NZ00P001	JB3030CWT-E-H57GA0000-NZ00P001
	90	29	31.2	28.7	JB3030CWT-E-U57EA0000-NZ00P001	JB3030CWT-E-U57GA0000-NZ00P001
5000 K	80	31	33.8	31.1	JB3030CWT-E-H50EA0000-NZ00P001	JB3030CWT-E-H50GA0000-NZ00P001
	90	29	31.2	28.7	JB3030CWT-E-U50EA0000-NZ00P001	JB3030CWT-E-U50GA0000-NZ00P001
4000 K	80	31	34.2	31.5	JB3030CWT-E-H40EA0000-NZ00P001	JB3030CWT-E-H40GA0000-NZ00P001
	90	29	31.2	28.7	JB3030CWT-E-U40EA0000-NZ00P001	JB3030CWT-E-U40GA0000-NZ00P001
3500 K	80	31	33.2	30.6	JB3030CWT-E-H35EA0000-NZ00P001	JB3030CWT-E-H35GA0000-NZ00P001
	90	29	30.8	28.4	JB3030CWT-E-U35EA0000-NZ00P001	JB3030CWT-E-U35GA0000-NZ00P001
3000 K	80	31	33	30.4	JB3030CWT-E-H30EA0000-NZ00P001	JB3030CWT-E-H30GA0000-NZ00P001
	90	29	30.5	28.1	JB3030CWT-E-U30EA0000-NZ00P001	JB3030CWT-E-U30GA0000-NZ00P001
2700 K	80	31	32.4	29.8	JB3030CWT-E-H27EA0000-NZ00P001	JB3030CWT-E-H27GA0000-NZ00P001
	90	27	29.5	27.2	JB3030CWT-E-U27EA0000-NZ00P001	JB3030CWT-E-U27GA0000-NZ00P001

Notes:

- Cree Venture maintains a tolerance of ±7% on flux and power measurements, ±0.005 on chromaticity (CC_x, CC_y) measurements and ±2 on CRI measurements. See the Measurements section (page 25).
- J Series JB3030C 3-V E & F Class Pro9 LED order codes specify only a minimum flux bin and not a maximum. Cree Venture may ship reels in flux bins higher than the minimum specified by the order code without advance notice. Shipments will always adhere to the chromaticity restrictions specified by the order code.
- * Flux values @ 85 °C are calculated and for reference only.
- ** Contact your Cree sales representative for kitted 3-step order code details.

FLUX CHARACTERISTICS, ORDER CODES AND BINS – JB3030C 3-V F CLASS PRO9 (I_F = 55 mA, T_J = 25 °C)

F Class

The following table provides order codes for J Series JB3030C 3-V F Class Pro9 LEDs. For a complete description of the order code nomenclature, please see the Order Code and Bin Code Formats section (page 3). For definitions of the chromaticity kits, please see the Performance Groups - Chromaticity section page 16).

CCT	Minimum CRI	Minimum Flux	Typical Flux (lm) @ 25 °C	Typical Flux (lm) @ 85 °C*	Kitted 3-Step Order Code	3-Step Order Code
6500 K	80	31	33.1	30.5	JB3030CWT-F-H65EA0000-NZ00P001	JB3030CWT-F-H65GA0000-NZ00P001
	90	29	30.4	28	JB3030CWT-F-U65EA0000-NZ00P001	JB3030CWT-F-U65GA0000-NZ00P001
5700 K	80	31	33.3	30.7	JB3030CWT-F-H57EA0000-NZ00P001	JB3030CWT-F-H57GA0000-NZ00P001
	90	29	30.6	28.2	JB3030CWT-F-U57EA0000-NZ00P001	JB3030CWT-F-U57GA0000-NZ00P001
5000 K	80	31	33.5	30.8	JB3030CWT-F-H50EA0000-NZ00P001	JB3030CWT-F-H50GA0000-NZ00P001
	90	29	30.6	28.2	JB3030CWT-F-U50EA0000-NZ00P001	JB3030CWT-F-U50GA0000-NZ00P001
4000 K	80	31	33.9	31.2	JB3030CWT-F-H40EA0000-NZ00P001	JB3030CWT-F-H40GA0000-NZ00P001
	90	29	30.6	28.2	JB3030CWT-F-U40EA0000-NZ00P001	JB3030CWT-F-U40GA0000-NZ00P001
3500 K	80	31	32.9	30.3	JB3030CWT-F-H35EA0000-NZ00P001	JB3030CWT-F-H35GA0000-NZ00P001
	90	29	30.3	27.9	JB3030CWT-F-U35EA0000-NZ00P001	JB3030CWT-F-U35GA0000-NZ00P001
3000 K	80	31	32.7	30.1	JB3030CWT-F-H30EA0000-NZ00P001	JB3030CWT-F-H30GA0000-NZ00P001
	90	27	30	27.6	JB3030CWT-F-U30EA0000-NZ00P001	JB3030CWT-F-U30GA0000-NZ00P001
2700 K	80	29	32.1	29.6	JB3030CWT-F-H27EA0000-NZ00P001	JB3030CWT-F-H27GA0000-NZ00P001
	90	27	29	26.7	JB3030CWT-F-U27EA0000-NZ00P001	JB3030CWT-F-U27GA0000-NZ00P001

Notes:

- Cree Venture maintains a tolerance of ±7% on flux and power measurements, ±0.005 on chromaticity (CC_x, CC_y) measurements and ±2 on CRI measurements. See the Measurements section (page 25).
- J Series JB3030C 3-V E & F Class Pro9 LED order codes specify only a minimum flux bin and not a maximum. Cree Venture may ship reels in flux bins higher than the minimum specified by the order code without advance notice. Shipments will always adhere to the chromaticity restrictions specified by the order code.
- * Flux values @ 85 °C are calculated and for reference only.
- ** Contact your Cree sales representative for kitted 3-step order code details.

RELATIVE LUMINOUS FLUX VS. CURRENT

JB3030C 3-V 80 CRI Pro9

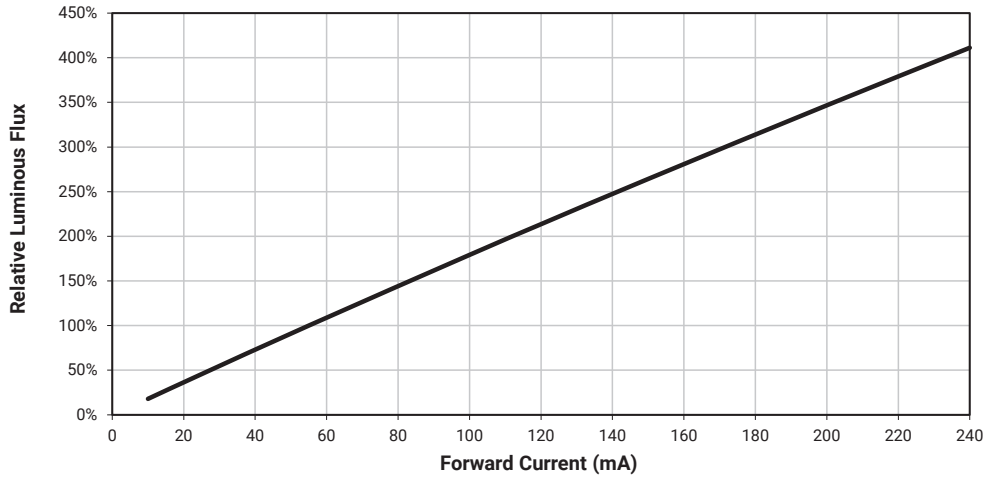

JB3030C 3-V 90 CRI Pro9

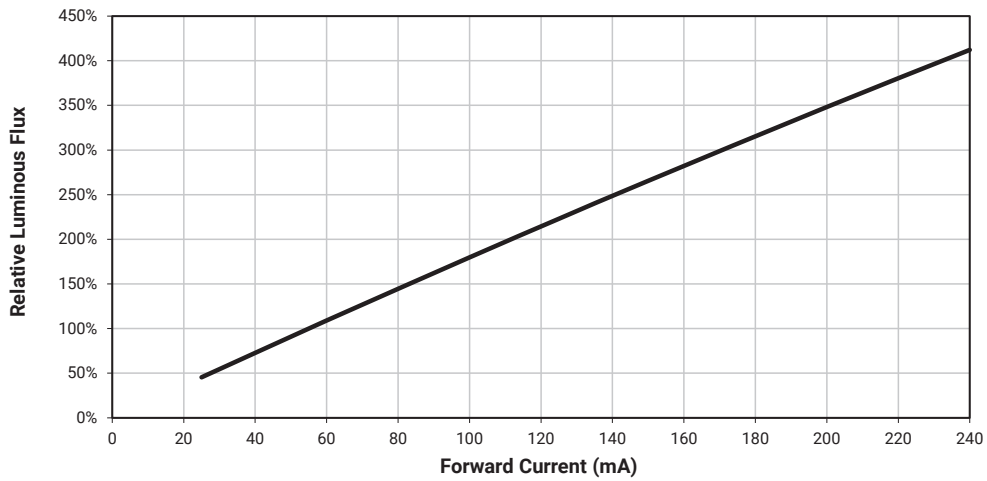

ELECTRICAL CHARACTERISTICS

JB3030C 3-V E Class Pro9

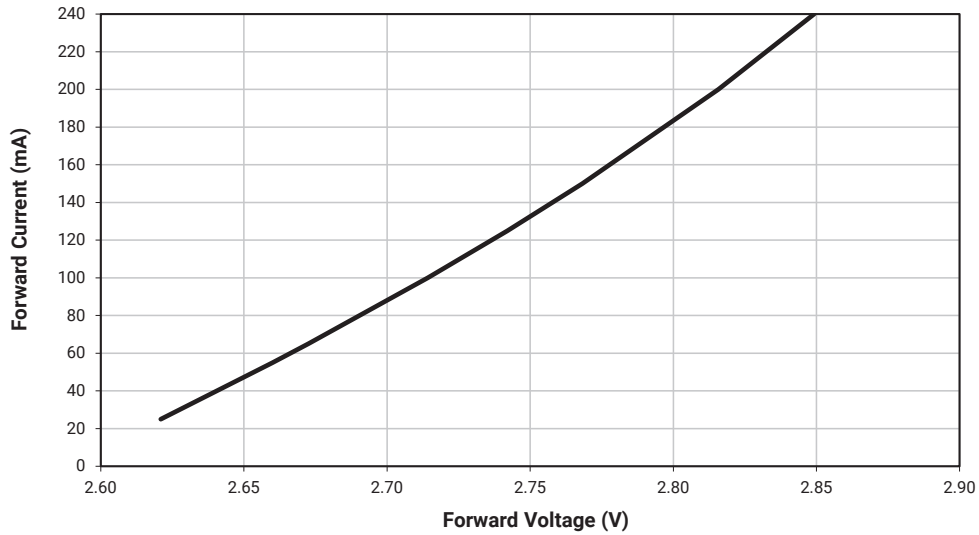

JB3030C 3-V F Class Pro9

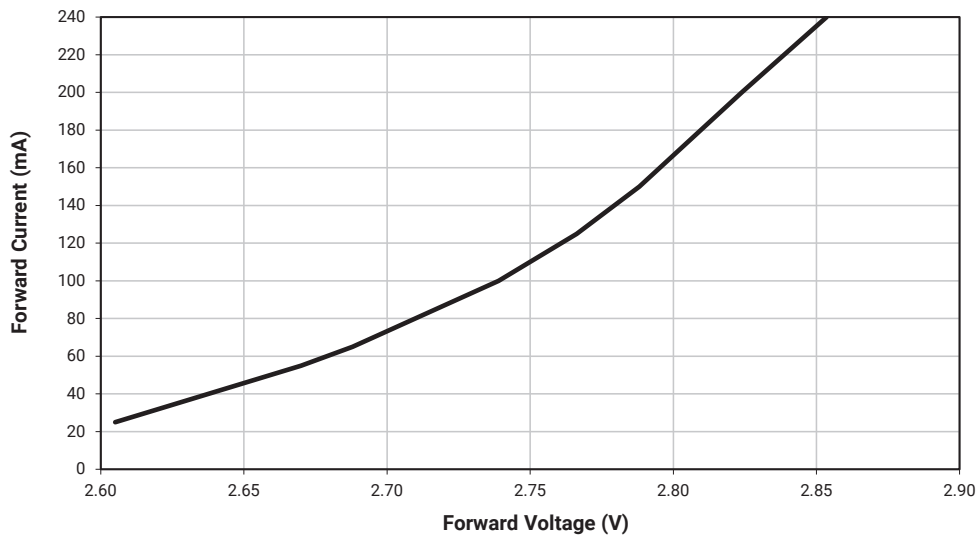

RELATIVE CHROMATICITY VS. CURRENT

JB3030C 3-V 80 CRI Pro9

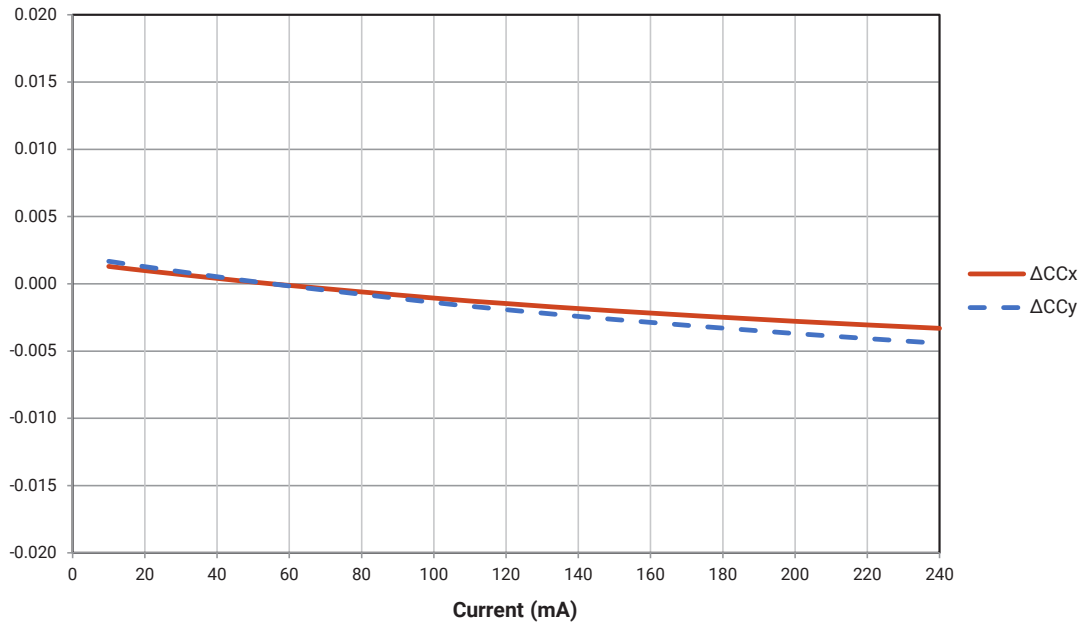

JB3030C 3-V 90 CRI Pro9

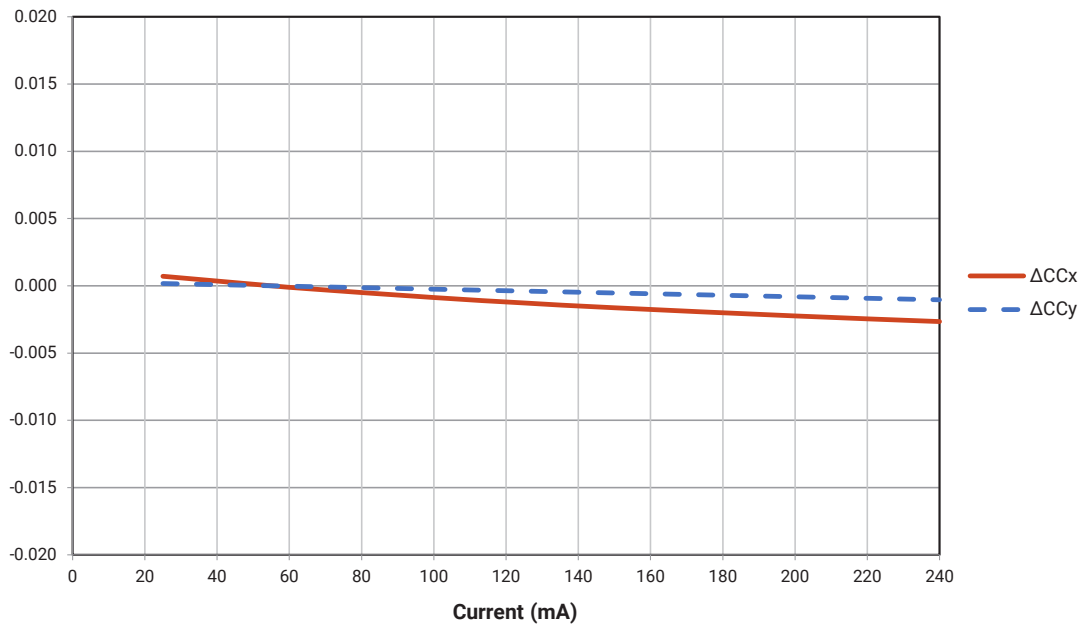

RELATIVE CHROMATICITY VS. JUNCTION TEMPERATURE

JB3030C 3-V 80 CRI Pro9

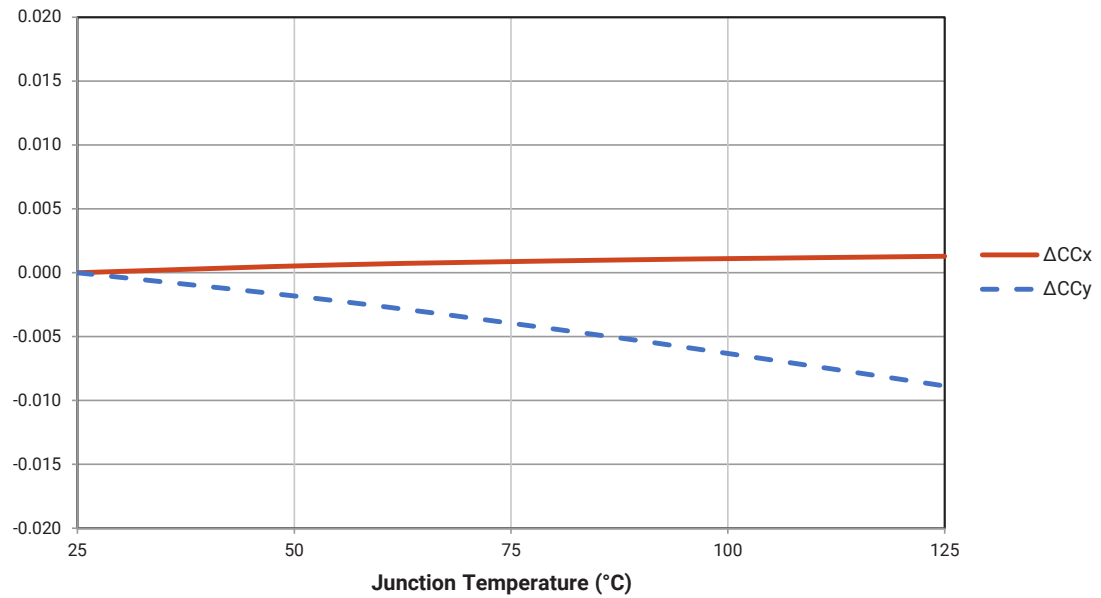

JB3030C 3-V 90 CRI Pro9

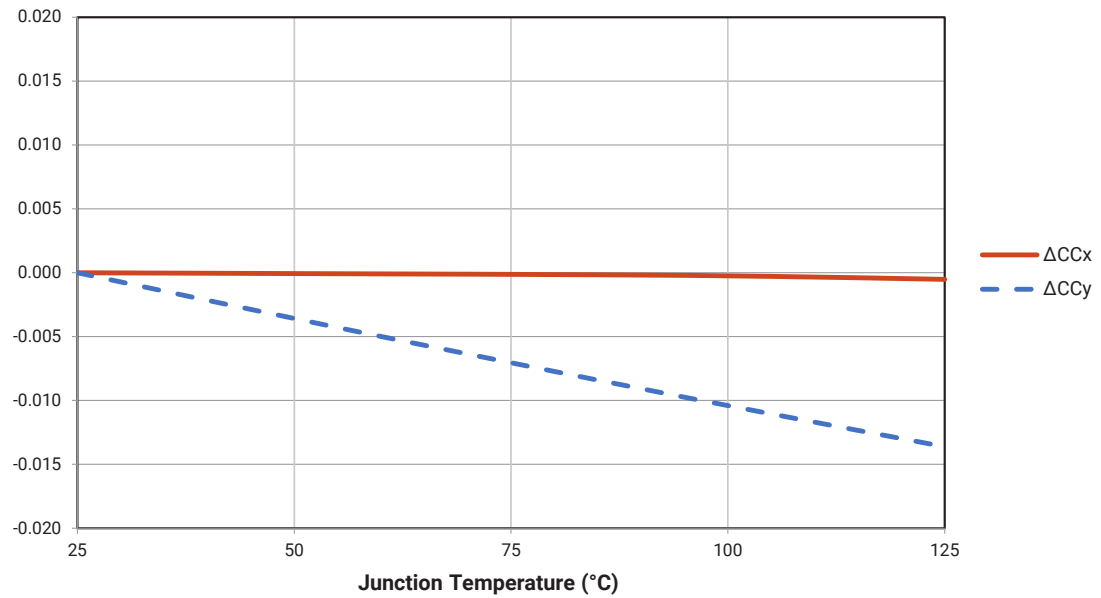

RELATIVE SPECTRAL POWER DISTRIBUTION

JB3030C 3-V E Class 80 CRI Pro9

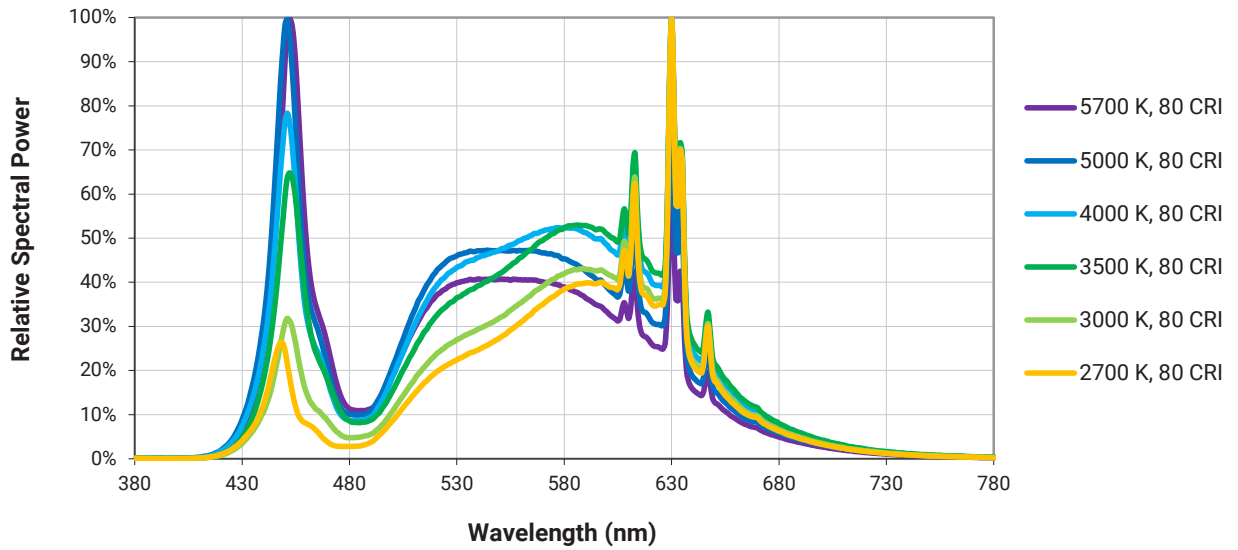

JB3030C 3-V E Class 90 CRI Pro9

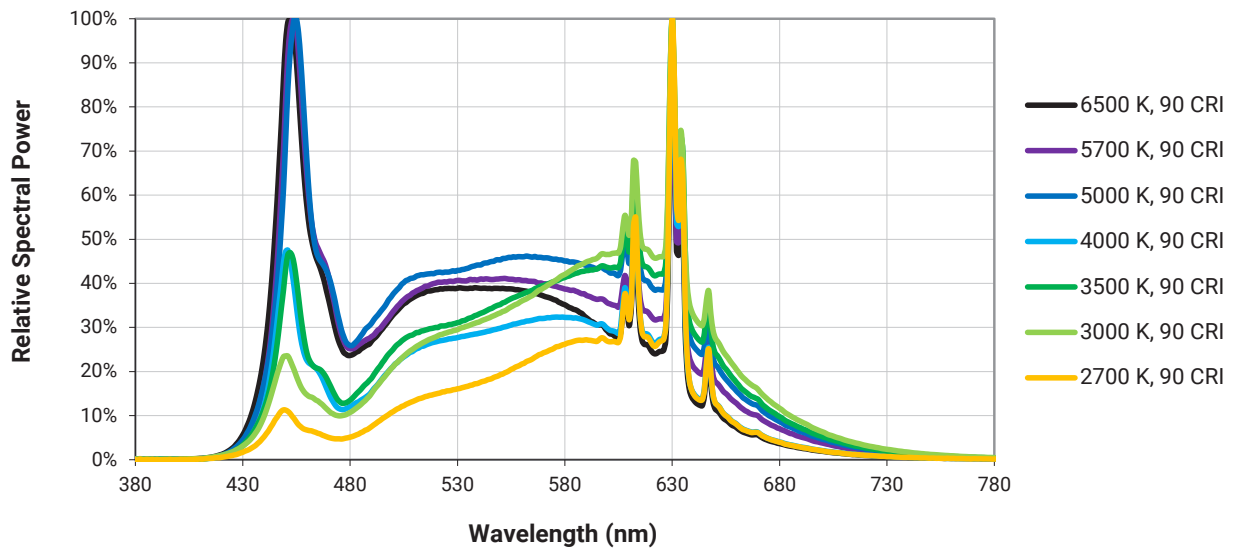

RELATIVE LUMINOUS FLUX VS. JUNCTION TEMPERATURE

JB3030C 3-V 80 CRI Pro9

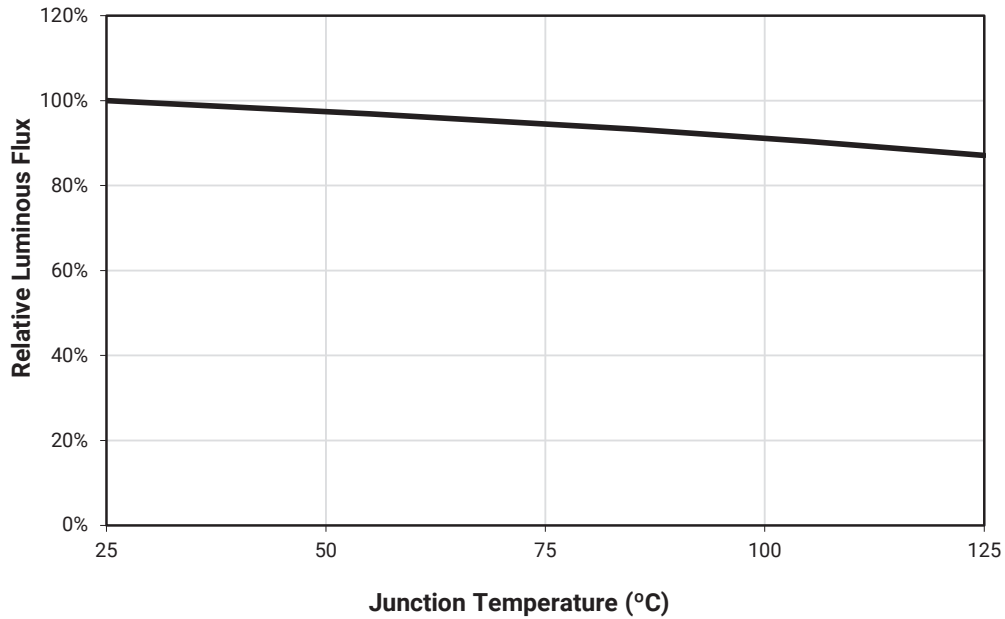

JB3030C 3-V 90 CRI Pro9

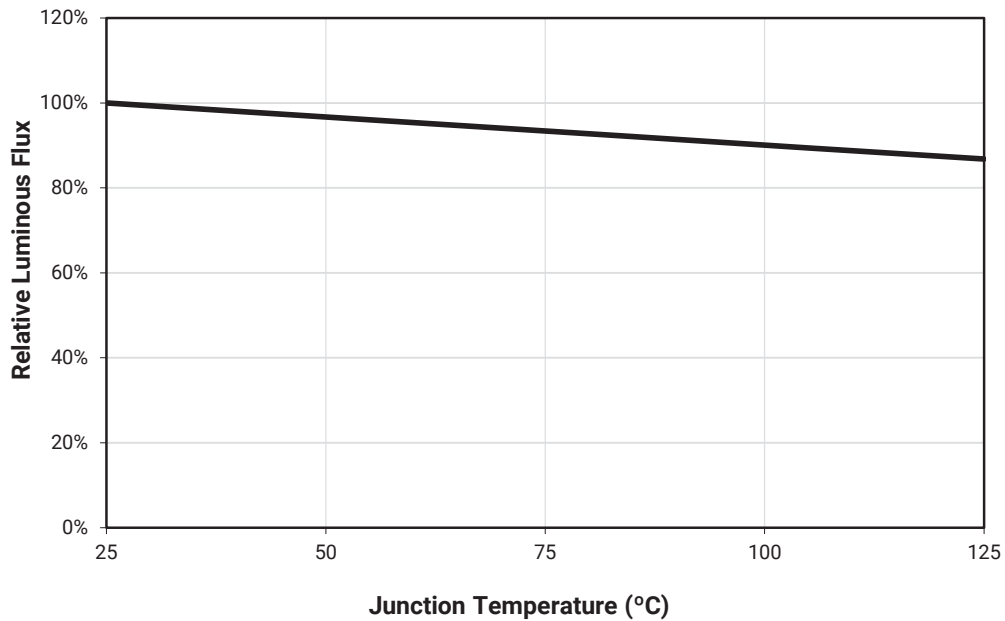

TYPICAL SPATIAL DISTRIBUTION

JB3030C 3-V 80 CRI Pro9

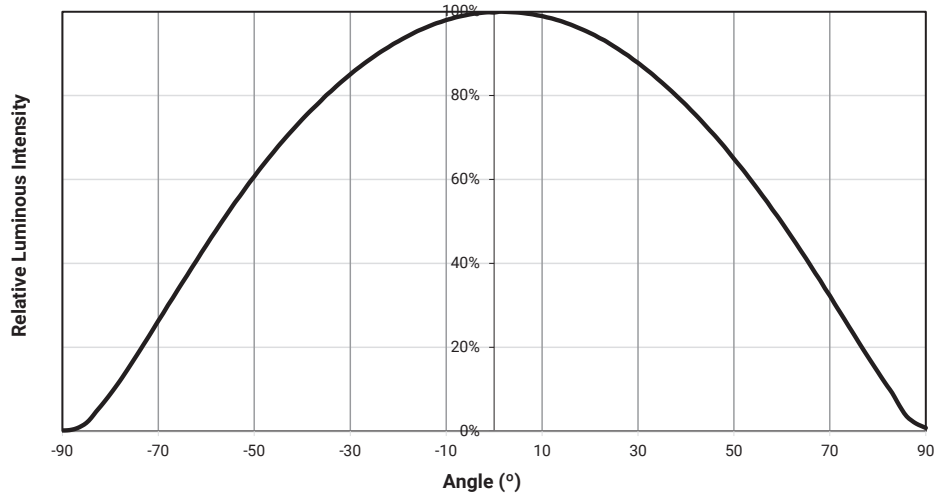

JB3030C 3-V 90 CRI Pro9

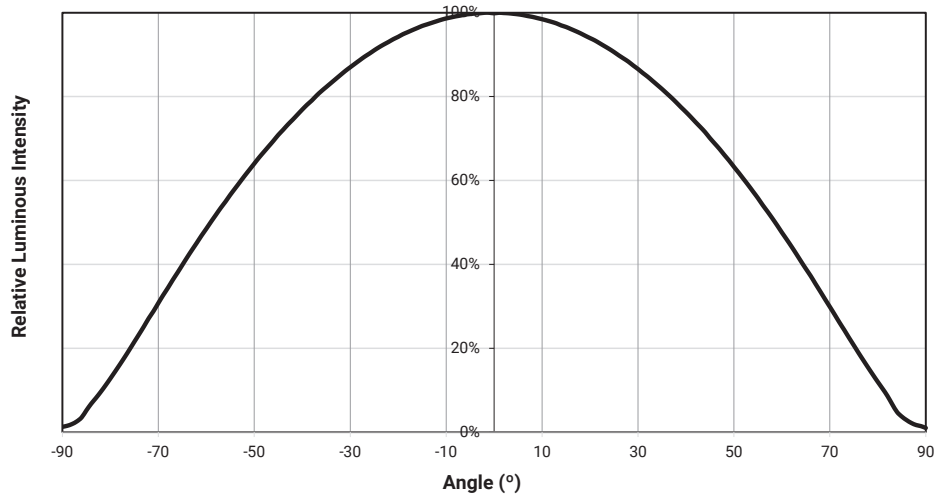

PERFORMANCE GROUPS - LUMINOUS FLUX ($T_j = 25\text{ }^\circ\text{C}$)

J Series JB3030C 3-V E & F Class Pro9 LEDs are tested for luminous flux at 55 mA and placed into one of the following luminous-flux groups.

Group Code	Minimum Luminous Flux (lm)	Maximum Luminous Flux (lm)
D6	27	29
D7	29	31
D8	31	33
D9	33	35
E6	35	37

PERFORMANCE GROUPS - FORWARD VOLTAGE ($T_j = 25\text{ }^\circ\text{C}$)

J Series JB3030C 3-V E & F Class Pro9 LEDs are tested for forward voltage and placed into one of the following voltage bins.

The following voltage bins are indicated in the Forward Voltage Bin field in the bin code for JB3030C 3-V E & F Class Pro9 LEDs.

Voltage Bin	Minimum Forward Voltage (V)	Maximum Forward Voltage (V)
AC	2.6	2.7
AD	2.7	2.8

PERFORMANCE GROUPS - CHROMATICITY ($T_j = 25\text{ }^\circ\text{C}$)

J Series JB3030C 3-V E & F Class LEDs are tested for chromaticity and placed into one of the regions defined by the following bounding coordinates.

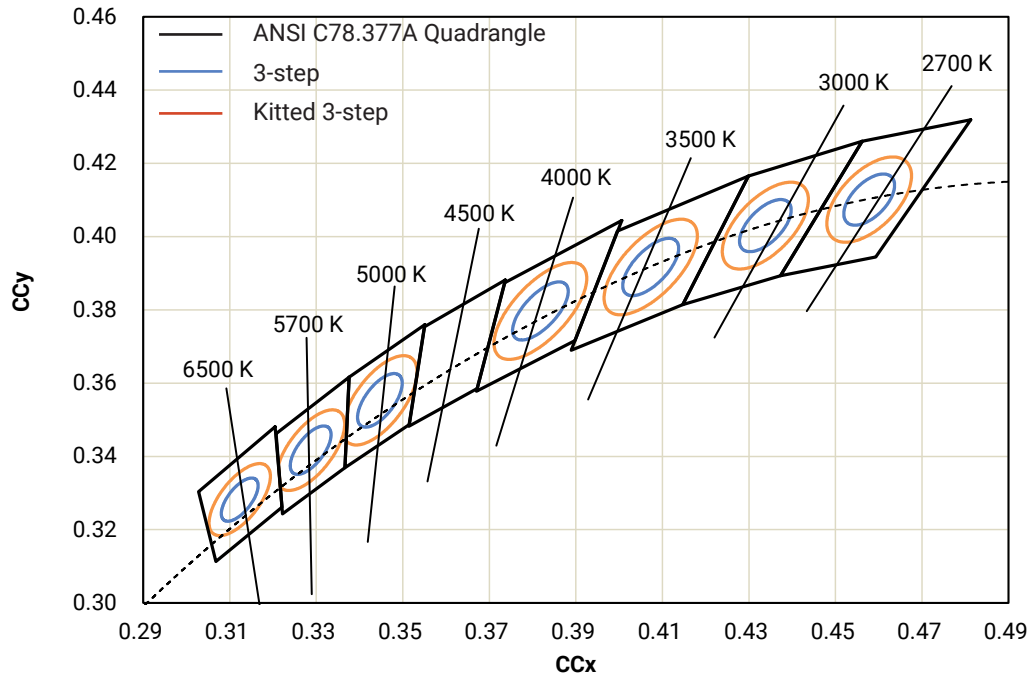

PERFORMANCE GROUPS - CHROMATICITY - CONTINUED ($T_j = 25\text{ }^\circ\text{C}$)

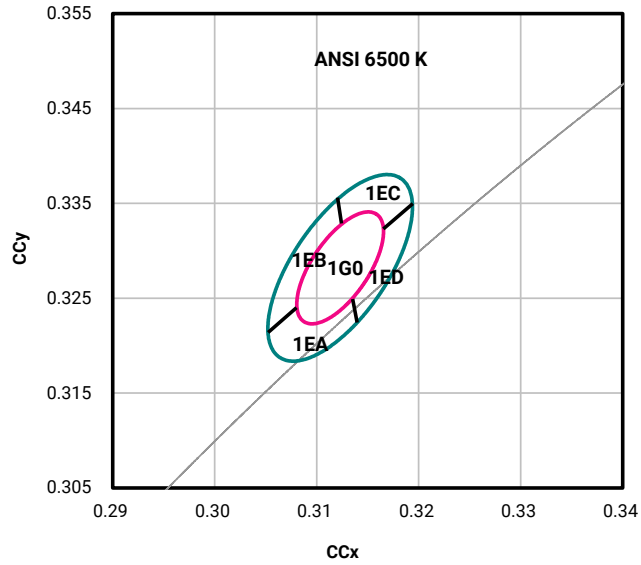

CCT	MacAdam Ellipse	Included Bins	Center Point		Major Axis	Minor Axis	Rotation Angle (°)
			x	y	a	b	
6500 K	3-step	1G0	0.3123	0.3282	0.00669	0.00285	58.57
	Kitted 3-step	1G0, 1EA, 1EB, 1EC, 1ED	0.3123	0.3282	0.01115	0.00475	58.57

PERFORMANCE GROUPS - CHROMATICITY - CONTINUED ($T_j = 25\text{ }^\circ\text{C}$)

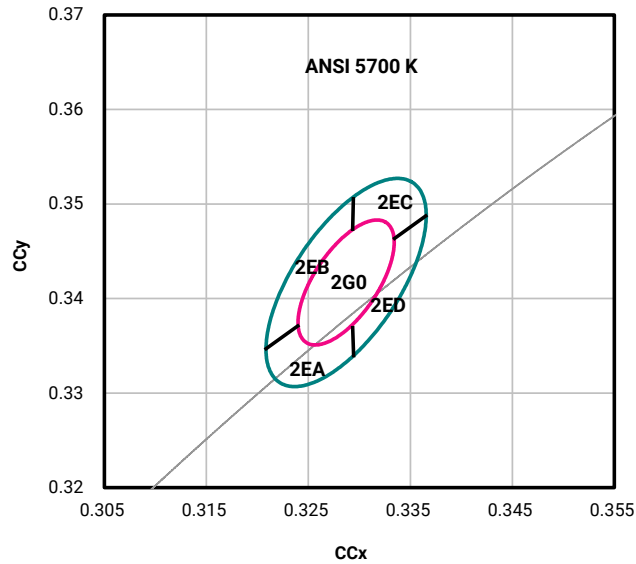

CCT	MacAdam Ellipse	Included Bins	Center Point		Major Axis	Minor Axis	Rotation Angle (°)
			x	y	a	b	
5700 K	3-step	2G0	0.3287	0.3417	0.00746	0.00320	59.09
	Kitted 3-step	2G0, 2EA, 2EB, 2EC, 2ED	0.3287	0.3417	0.01243	0.00533	59.09

PERFORMANCE GROUPS - CHROMATICITY - CONTINUED ($T_j = 25\text{ }^\circ\text{C}$)

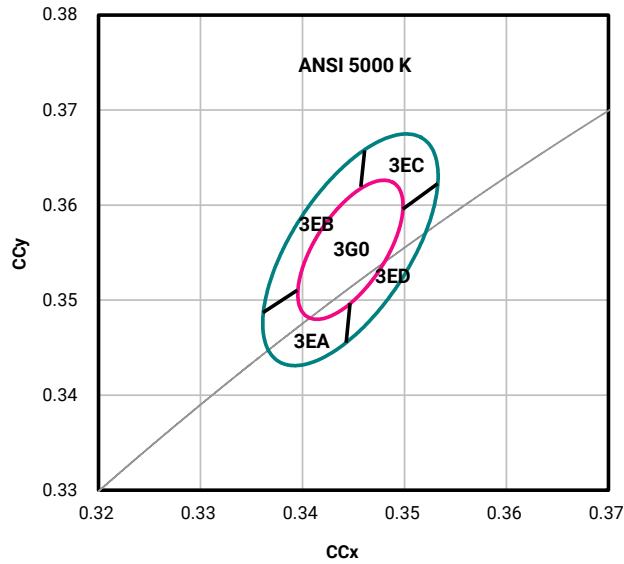

CCT	MacAdam Ellipse	Included Bins	Center Point		Major Axis	Minor Axis	Rotation Angle (°)
			x	y	a	b	
5000 K	3-step	3G0	0.3447	0.3553	0.00822	0.00354	59.62
	Kitted 3-step	3G0, 3EA, 3EB, 3EC, 3ED	0.3447	0.3553	0.01370	0.00590	59.62

PERFORMANCE GROUPS - CHROMATICITY - CONTINUED ($T_j = 25\text{ °C}$)

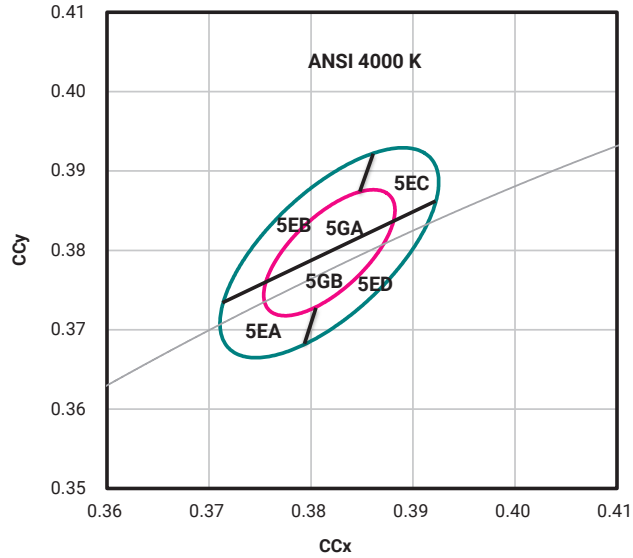

CCT	MacAdam Ellipse	Included Bins	Center Point		Major Axis	Minor Axis	Rotation Angle (°)
			x	y	a	b	
4000 K	3-step	5GA, 5GB	0.3818	0.3797	0.00939	0.00402	53.72
	Kitted 3-step	5GA, 5GB, 5EA, 5EB, 5EC, 5ED	0.3818	0.3797	0.01565	0.00670	53.72

PERFORMANCE GROUPS - CHROMATICITY - CONTINUED ($T_j = 25\text{ }^\circ\text{C}$)

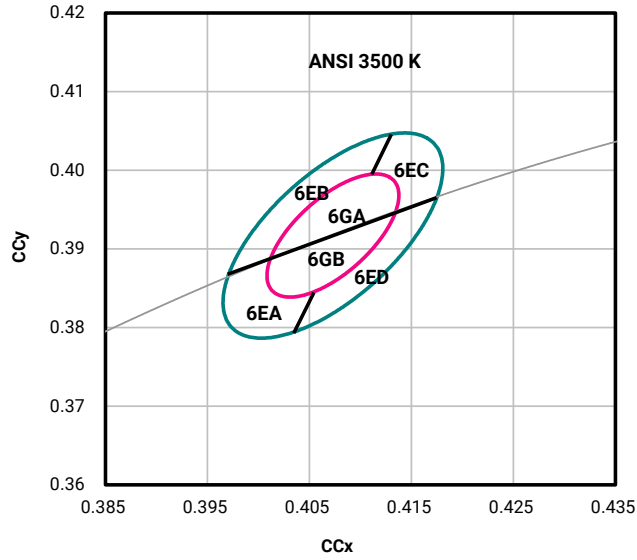

CCT	MacAdam Ellipse	Included Bins	Center Point		Major Axis	Minor Axis	Rotation Angle (°)
			x	y	a	b	
3500 K	3-step	6GA, 6GB	0.4073	0.3917	0.00927	0.00414	54.00
	Kitted 3-step	6GA, 6GB, 6EA, 6EB, 6EC, 6ED	0.4073	0.3917	0.01545	0.00690	54.00

PERFORMANCE GROUPS - CHROMATICITY - CONTINUED ($T_j = 25\text{ }^\circ\text{C}$)

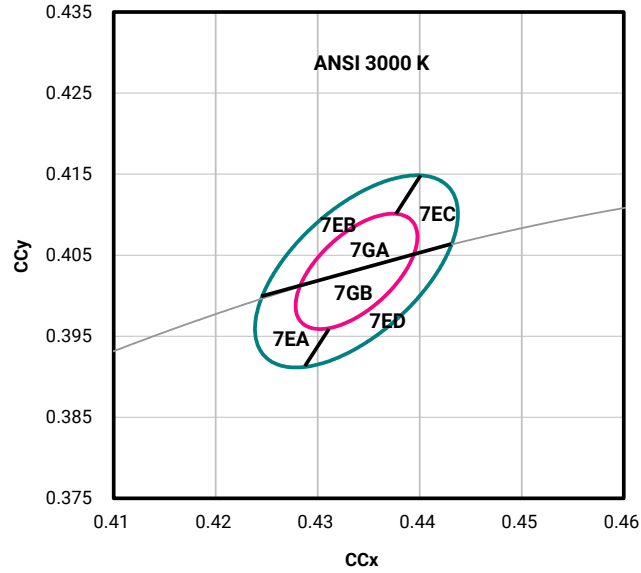

CCT	MacAdam Ellipse	Included Bins	Center Point		Major Axis	Minor Axis	Rotation Angle (°)
			x	y	a	b	
3000 K	3-step	7GA, 7GB	0.4338	0.4030	0.00834	0.00408	53.22
	Kitted 3-step	7GA, 7GB, 7EA, 7EB 7EC, 7ED	0.4338	0.4030	0.01390	0.00680	53.22

PERFORMANCE GROUPS - CHROMATICITY - CONTINUED ($T_j = 25\text{ °C}$)

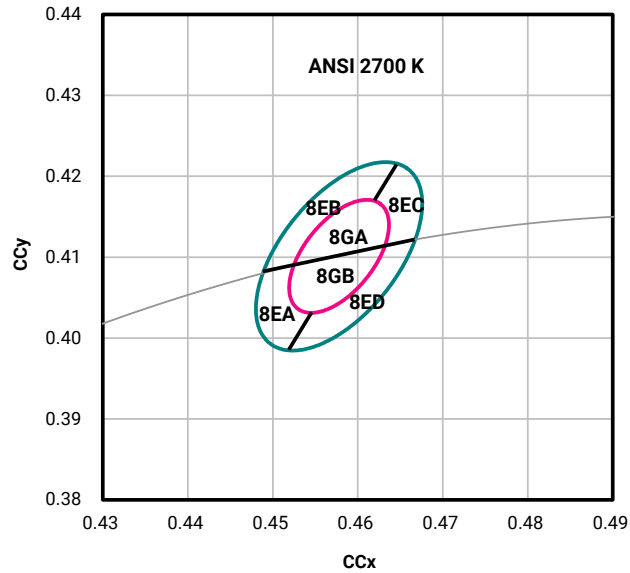

CCT	MacAdam Ellipse	Included Bins	Center Point		Major Axis	Minor Axis	Rotation Angle (°)
			x	y	a	b	
2700 K	3-step	8GA, 8GB	0.4578	0.4101	0.00810	0.00420	53.70
	Kitted 3-step	8GA, 8GB, 8EA, 8EB, 8EC, 8ED	0.4578	0.4101	0.01350	0.00700	53.70

REFLOW SOLDERING CHARACTERISTICS

In testing, Cree Venture has found J Series JB3030C 3-V E & F Class LEDs to be compatible with JEDEC J-STD-020C, using the parameters listed below. As a general guideline, Cree Venture recommends that users follow the recommended soldering profile provided by the manufacturer of the solder paste used, and therefore it is the lamp or luminaire manufacturer’s responsibility to determine applicable soldering requirements.

Note that this general guideline may not apply to all PCB designs and configurations of reflow soldering equipment.

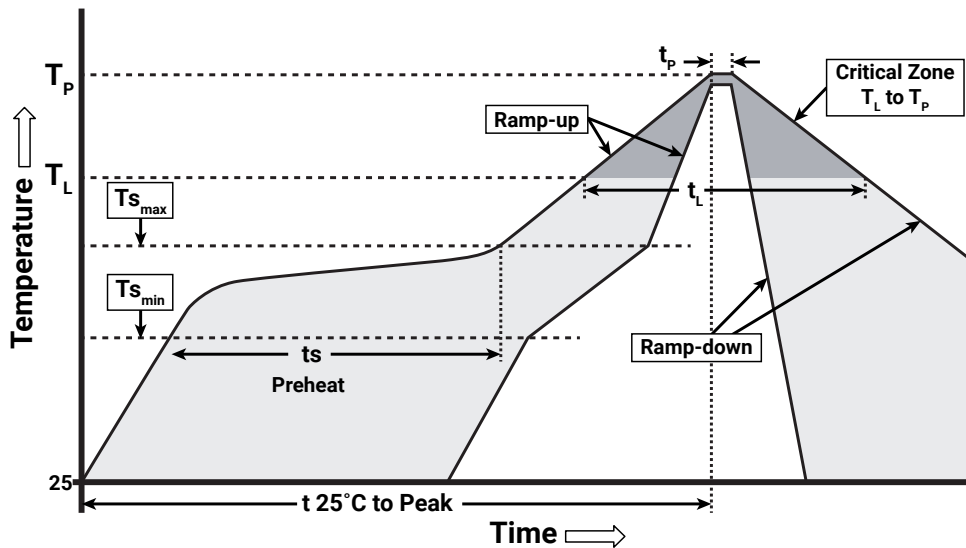

IPC/JEDEC J-STD-020C

Profile Feature	Lead-Free Solder
Average Ramp-Up Rate ($T_{s_{max}}$ to T_p)	1.2 °C/second
Preheat: Temperature Min ($T_{s_{min}}$)	120 °C
Preheat: Temperature Max ($T_{s_{max}}$)	170 °C
Preheat: Time ($t_{s_{min}}$ to $t_{s_{max}}$)	65-150 seconds
Time Maintained Above: Temperature (T_L)	217 °C
Time Maintained Above: Time (t_L)	45-90 seconds
Peak/Classification Temperature (T_p)	235 - 245 °C
Time Within 5 °C of Actual Peak Temperature (t_p)	20-40 seconds
Ramp-Down Rate	1 - 6 °C/second
Time 25 °C to Peak Temperature	4 minutes max.

Note: All temperatures refer to the topside of the package, measured on the package body surface.

NOTES

LED Use

Use of this LED in information displays utilizing LCD backlights and other emissive pixel display technology is prohibited (“Use Restrictions”).

Measurements

The luminous flux, radiant power, chromaticity, forward voltage and CRI measurements in this document are binning specifications only and solely represent product measurements as of the date of shipment. These measurements will change over time based on a number of factors that are not within Cree Venture’s control and are not intended or provided as operational specifications for the products. Calculated values are provided for informational purposes only and are not intended or provided as specifications.

Pre-Release Qualification Testing

Please read the [J Series Reliability Overview](#) for the details of the pre-release qualification testing for J Series LEDs.

Lumen Maintenance

Cree Venture uses standardized IES LM-80-08 and TM-21-11 methods for collecting long-term data and extrapolating LED lumen maintenance. For information on the specific LM-80 data sets available for this LED, refer to the public [J Series LM-80 results document](#).

Please read the [Thermal Management application note](#) for details on how thermal design, ambient temperature, and drive current affect the LED junction temperature.

Moisture Sensitivity

Cree Venture recommends keeping J Series JB3030C 3-V E & F Class LEDs in the provided, resealable moisture-barrier packaging (MBP) until immediately prior to soldering. Unopened MBP that contains J Series JB3030C 3-V E & F Class LEDs does not need special storage for moisture sensitivity.

Once the MBP is opened, J Series JB3030C 3-V E & F Class LEDs should be handled and stored as MSL 3 per JEDEC J-STD-033, meaning they have limited exposure time before damage to the LED may occur during the soldering operation. The table on the right specifies the maximum exposure time in days depending on temperature and humidity conditions. LEDs with exposure time longer than the specified maximums must be baked according to the baking conditions listed below.

Moisture Sensitivity Level	Temp.	Maximum Percent Relative Humidity				
		50%	60%	70%	80%	90%
Level 3	35 °C	8	5	1	0.5	0.5
Level 3	30 °C	11	7	1	1	1
Level 3	25 °C	14	10	2	1	1
Level 3	20 °C	20	13	2	1	1

Baking Conditions

It is not necessary to bake all J Series JB3030C 3-V E & F Class LEDs. Only the LEDs that meet all of the following criteria must be baked:

1. LEDs that have been removed from the original MBP.
2. LEDs that have been exposed to a humid environment longer than listed in the Moisture Sensitivity section above.
3. LEDs that have not been soldered.

NOTES - CONTINUED

LEDs should be baked at 60 °C for 24 hours. LEDs may be baked in the original reels. Remove LEDs from the MBP before baking. Do not bake parts at temperatures higher than 60 °C. This baking operation resets the exposure time as defined in the Moisture Sensitivity section above.

RoHS Compliance

The levels of RoHS restricted materials in this product are below the maximum concentration values (also referred to as the threshold limits) permitted for such substances, or are used in an exempted application, in accordance with EU Directive 2011/65/EC (RoHS2), as implemented January 2, 2013. RoHS Declarations for this product can be obtained from your Cree LED representative or from the [Product Ecology](#) section of the Cree LED website.

REACH Compliance

REACH substances of very high concern (SVHCs) information is available for this product. Since the European Chemical Agency (ECHA) has published notice of their intent to frequently revise the SVHC listing for the foreseeable future, please contact a Cree LED representative to insure you get the most up-to-date REACH SVHC Declaration. REACH banned substance information (REACH Article 67) is also available upon request.

UL® Recognized Component

This product meets the requirements to be considered a UL Recognized Component with Level 4 enclosure consideration. The LED package or a portion thereof has been investigated as a fire and electrical enclosure per ANSI/UL 8750.

Vision Advisory

WARNING: Do not look at an exposed lamp in operation. Eye injury can result. For more information about LEDs and eye safety, please refer to the [J Series LED Eye Safety application note](#).

MECHANICAL DIMENSIONS

Vias, if present, are not shown on these drawings.
 All measurements are ±0.1 mm unless otherwise indicated.

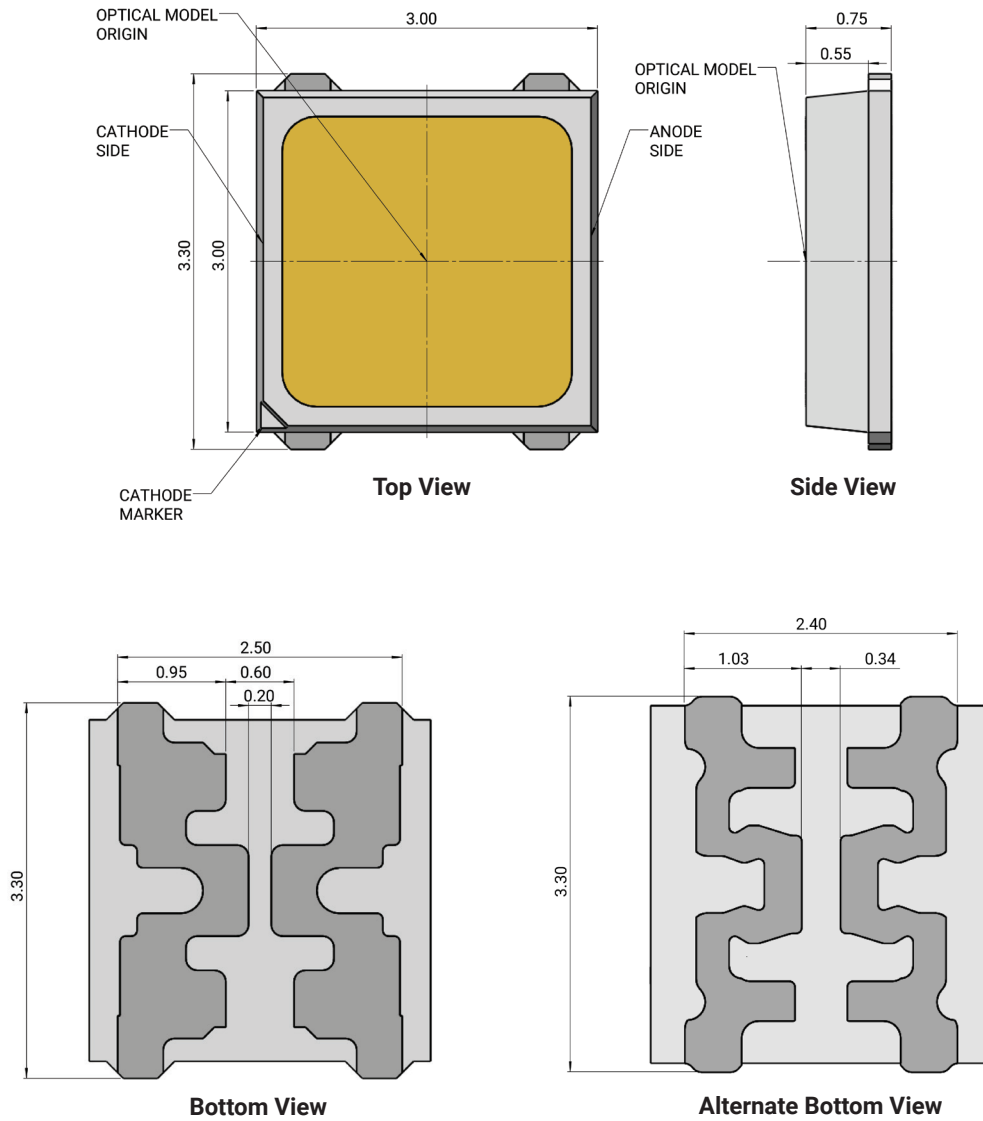

MECHANICAL DIMENSIONS - CONTINUED

Vias, if present, are not shown on these drawings.

All measurements are ± 0.1 mm unless otherwise indicated.

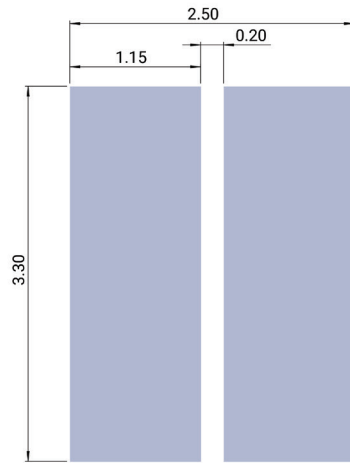

Recommended PCB Footprint

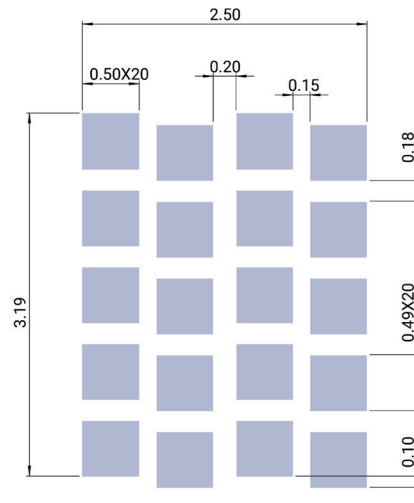

**Recommended Stencil Pattern
(Shaded Area Is Open)**

TAPE & REEL

All Cree Venture carrier tapes conform to EIA-481D, Automated Component Handling Systems Standard.

All dimensions in mm.

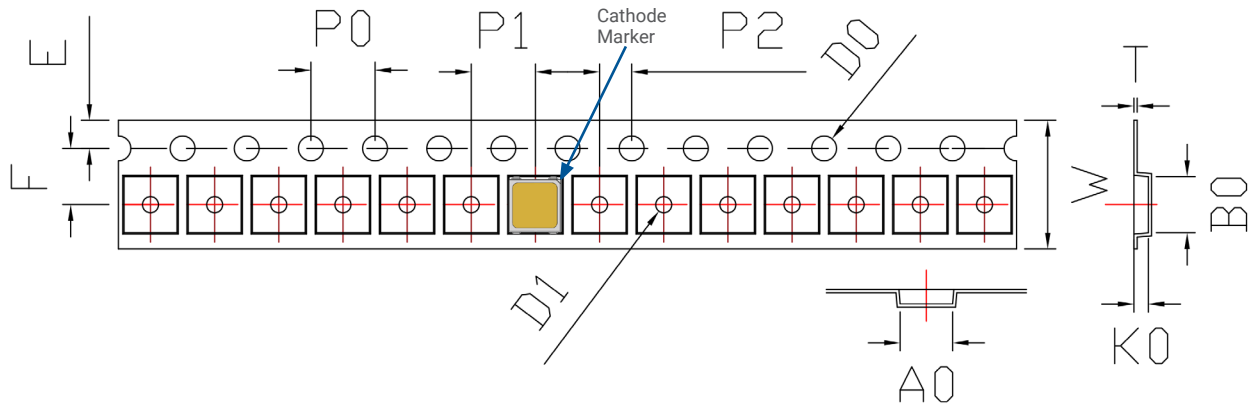

Item	A0	B0	K0	P0	P1	P2	T	E	F	D0	D1	W
Dim.	3.30±0.10	3.60±0.10	1.00±0.10	4.00±0.10	4.0±0.10	2.0±0.10	0.25±0.05	1.75±0.10	5.5±0.05	1.50+0.1 -0	1.50±0.10	12.0±0.2

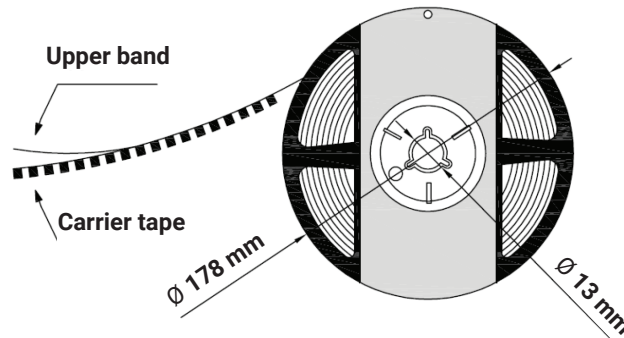
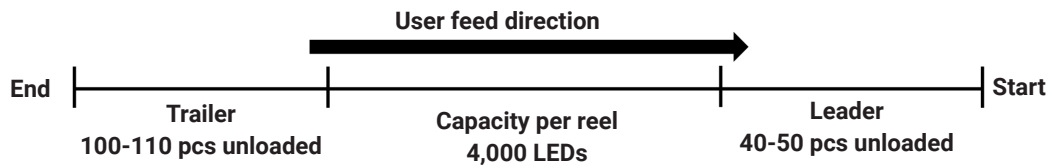

PACKAGING

Unpackaged Reel

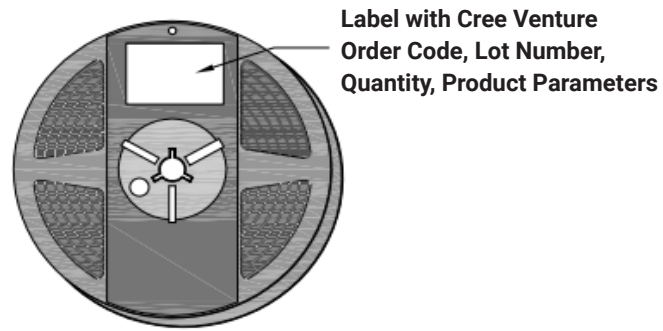

Packaged Reel

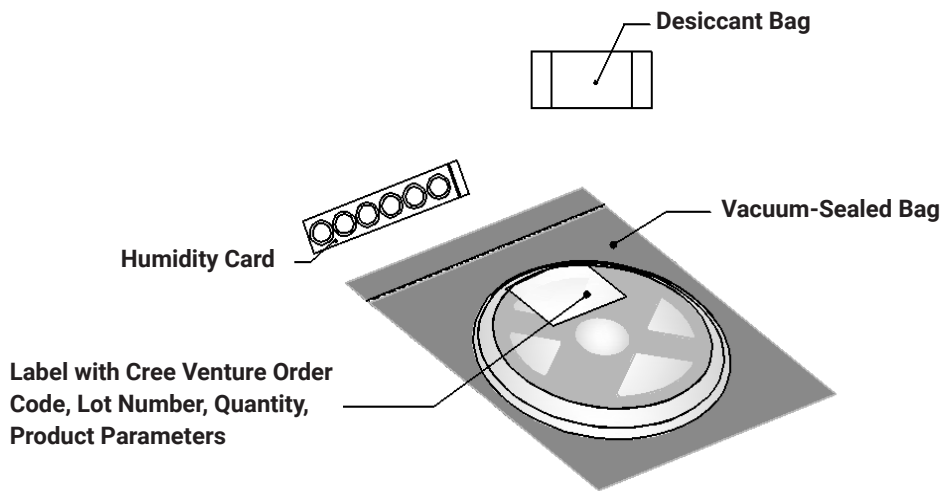

PACKAGING - CONTINUED

J Series JB3030C 3-V E & F Class LEDs are packaged in boxes for shipment. Box sizes and the number of reels per box are as follows.

Box	Box Dimensions	Maximum Number of Reels per Box
1	250 x 210 x 30 mm	2
2	250 x 210 x 50 mm	4
3	530 x 230 x 275 mm	44
4	530 x 443 x 275 mm	88

Each box has at least one label (shown as a white square in the diagrams below) showing the order code, lot number, quantity, and product parameters.

Box 1

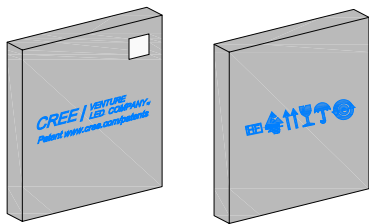

Box 2

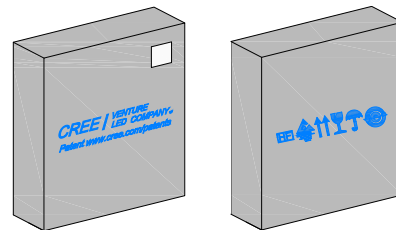

Box 3

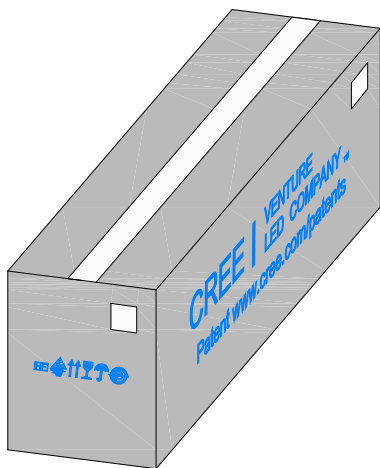

Box 4

