

J Series® JU7070B K Class LEDs

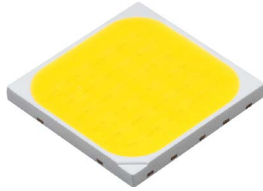

PRODUCT DESCRIPTION

J Series® LEDs provide excellent value for general and specialty lighting applications in the industry’s most common LED package sizes. JU7070B LEDs deliver excellent LPW up to 12 W and are well suited for lighting applications that have minimal optical control requirements. One JU7070B LED can replace many mid-power LEDs, leading to system designs that are simpler and more cost effective.

J Series JU7070B LEDs are optimized for lighting applications where high light output and simplicity are critical, such as outdoor area and indoor downlights.

FEATURES

- Industry-compatible size: 7.0 x 7.0 x 0.8 mm
- 12-V & 36-V configuration
- Flux binned at 25 °C, chromaticity binned at 85 °C
- 6500 K–2200 K ANSI CCTs available for 70, 80, & 90 CRI
- RoHS and REACH compliant

PRODUCT SUMMARY

Product	Power Class	Test Temperature	Test Current	Typical Forward Voltage	4000 K, 70 CRI		Maximum Current
					Typical Flux	Typical Efficacy	
JU7070B 12-V K Class	8 W	25 °C	700 mA	11.8 V	1580 lm	191.5 LPW	1200 mA
JU7070B 36-V K Class	8 W	25 °C	233 mA	35.4 V	1580 lm	191.5 LPW	400 mA



J Series® Products are sold exclusively by Cree Venture LED Company Limited (“Cree Venture”), regardless of geography. Any orders for J Series Products that are submitted to Cree LED or any of its other subsidiaries will be directed to Cree Venture for acknowledgment and order fulfillment.

Cree LED / 4001 E. Hwy. 54, Suite 2000 / Durham, NC 27709 USA / +1.919.313.5330 / www.cree-led.com

TABLE OF CONTENTS

Order Code & Bin Code Formats	3
Characteristics - JU7070B 12-V K Class	4
Operating Limits - JU7070B 12-V K Class	4
Flux Characteristics, Order Codes and Bins - JU7070B 12-V K Class	5
Relative Luminous Flux vs. Current - JU7070B 12-V K Class	6
Electrical Characteristics - JU7070B 12-V K Class	6
Relative Chromaticity vs. Current - JU7070B 12-V K Class	7
Relative Chromaticity vs. Junction Temperature - JU7070B 12-V K Class	7
Characteristics - JU7070B 36-V K Class	8
Operating Limits - JU7070B 36-V K Class	8
Flux Characteristics, Order Codes and Bins - JU7070B 36-V K Class	9
Relative Luminous Flux vs. Current - JU7070B 36-V K Class	10
Electrical Characteristics - JU7070B 36-V K Class	10
Relative Chromaticity vs. Current - JU7070B 36-V K Class	11
Relative Chromaticity vs. Junction Temperature - JU7070B 36-V K Class	11
Relative Luminous Flux vs. Junction Temperature	12
Typical Spatial Distribution.....	12
Relative Spectral Power Distribution	13
Performance Groups - Luminous Flux.....	14
Performance Groups - Forward Voltage.....	14
Performance Groups - Chromaticity	15
Reflow Soldering Characteristics.....	24
Notes	25
Mechanical Dimensions	27
Tape & Reel.....	28
Packaging.....	30

ORDER CODE & BIN CODE FORMATS

Order codes and bin codes for J Series JU7070B LEDs are configured in the following manner:

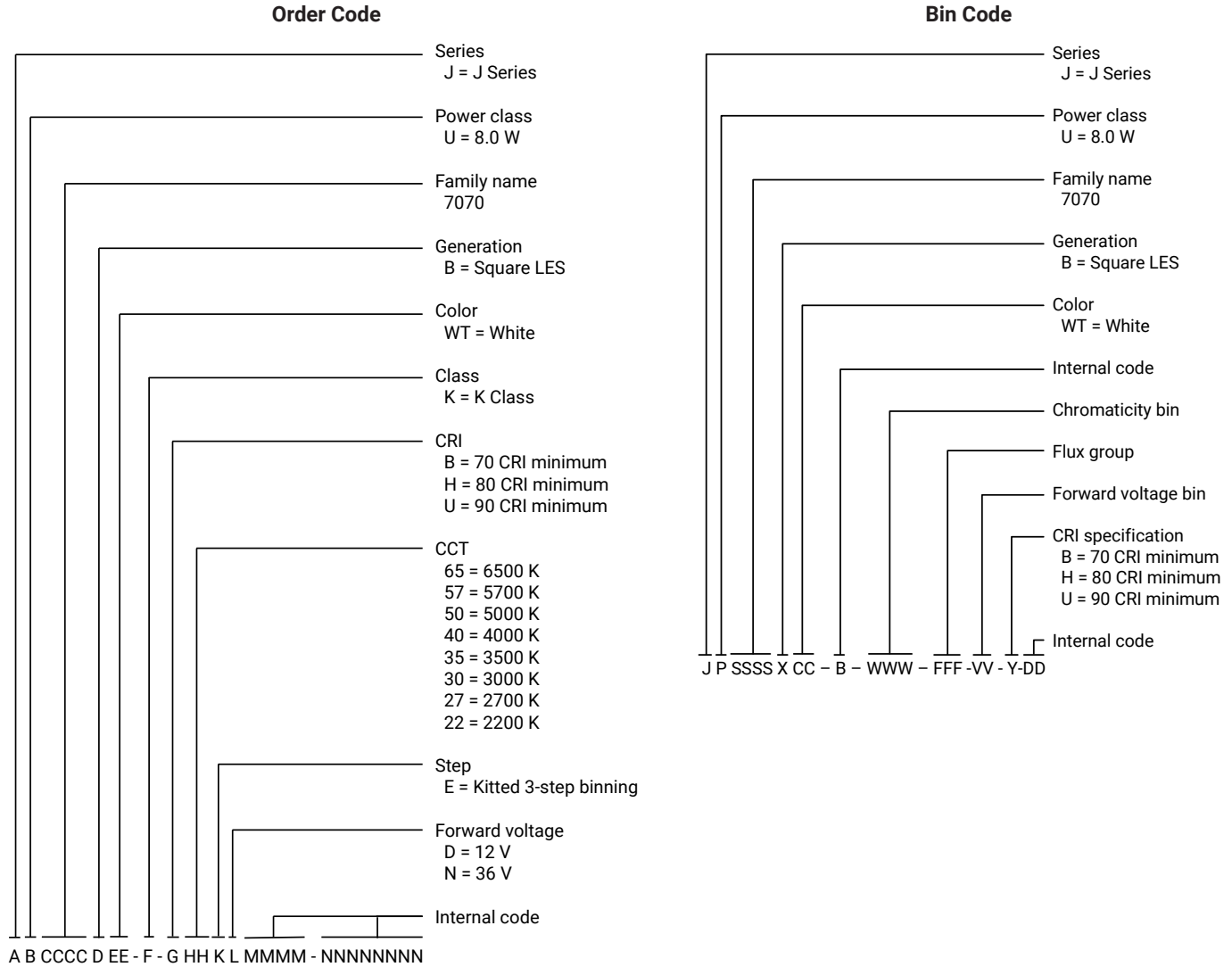

CHARACTERISTICS - JU7070B 12-V K CLASS

Characteristics	Unit	Minimum	Typical	Maximum
Thermal resistance, junction to solder point	°C/W		0.6	
Viewing angle (FWHM)	degrees		115	
Temperature coefficient of voltage	mV/°C		-4.2	
ESD withstand voltage (HBM per Mil-Std-883K)			Class 2	
DC forward current	mA			1200
Reverse voltage	V			5
Forward voltage (@ 700 mA, 25 °C)	V		11.8	12.5
LED junction temperature	°C			125
Operating temperature	°C	-40		105

OPERATING LIMITS - JU7070B 12-V K CLASS

The maximum forward current is determined by the thermal resistance between the LED junction and ambient.

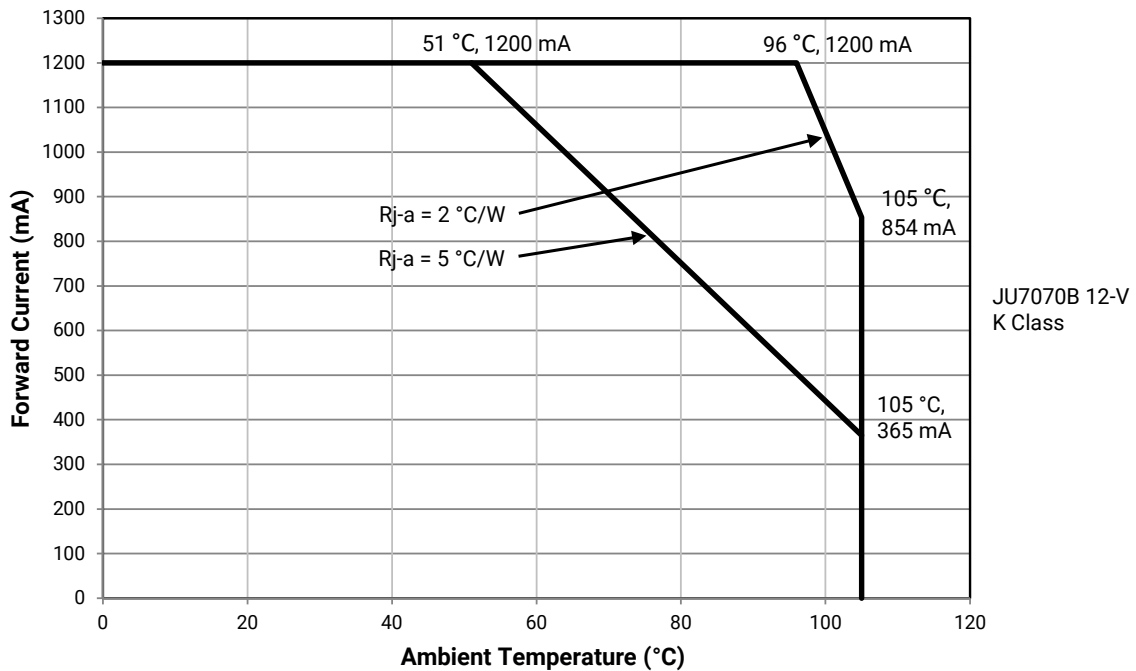

FLUX CHARACTERISTICS, ORDER CODES AND BINS - JU7070B 12-V K CLASS ($I_f = 700 \text{ mA}$, $T_j = 25 \text{ °C}$)

The following table provides order codes for J Series JU7070B 12-V K Class LEDs. For a complete description of the order code nomenclature, please see the Order Code and Bin Code Formats section (page 3). For definitions of the chromaticity kits, please see the Performance Groups - Chromaticity section (page 15).

Nominal CCT	Minimum CRI	Minimum Luminous Flux (lm) @ 25 °C	Typical Luminous Flux (lm) @ 25 °C	Typical Luminous Flux (lm) @ 85 °C*	Kitted 3-Step Order Code**
6500 K	70	1500	1580	1438	JU7070BWT-K-B65ED0000-N0000001
	80	1400	1475	1342	JU7070BWT-K-H65ED0000-N0000001
	90	1250	1320	1201	JU7070BWT-K-U65ED0000-N0000001
5700 K	70	1500	1580	1438	JU7070BWT-K-B57ED0000-N0000001
	80	1400	1475	1342	JU7070BWT-K-H57ED0000-N0000001
	90	1250	1320	1201	JU7070BWT-K-U57ED0000-N0000001
5000 K	70	1500	1580	1438	JU7070BWT-K-B50ED0000-N0000001
	80	1400	1475	1342	JU7070BWT-K-H50ED0000-N0000001
	90	1250	1320	1201	JU7070BWT-K-U50ED0000-N0000001
4000 K	70	1500	1580	1438	JU7070BWT-K-B40ED0000-N0000001
	80	1400	1475	1342	JU7070BWT-K-H40ED0000-N0000001
	90	1250	1320	1201	JU7070BWT-K-U40ED0000-N0000001
3500 K	70	1450	1525	1388	JU7070BWT-K-B35ED0000-N0000001
	80	1350	1418	1290	JU7070BWT-K-H35ED0000-N0000001
	90	1200	1265	1151	JU7070BWT-K-U35ED0000-N0000001
3000 K	70	1400	1495	1360	JU7070BWT-K-B30ED0000-N0000001
	80	1300	1390	1265	JU7070BWT-K-H30ED0000-N0000001
	90	1150	1240	1128	JU7070BWT-K-U30ED0000-N0000001
2700 K	70	1400	1465	1333	JU7070BWT-K-B27ED0000-N0000001
	80	1300	1362	1239	JU7070BWT-K-H27ED0000-N0000001
	90	1100	1200	1092	JU7070BWT-K-U27ED0000-N0000001
2200 K	70	1250	1350	1229	JU7070BWT-K-B22ED0000-N0000001
	80	1150	1228	1117	JU7070BWT-K-H22ED0000-N0000001
	90	1000	1081	984	JU7070BWT-K-U22ED0000-N0000001

Notes:

- Cree Venture maintains a tolerance of $\pm 7\%$ on flux and power measurements, ± 0.005 on chromaticity (CCx, CCy) measurements and ± 2 on CRI measurements. See the Measurements section (page 25).
- Cree Venture J Series JU7070B K Class LED order codes specify only a minimum flux bin and not a maximum. Cree Venture may ship reels in flux bins higher than the minimum specified by the order code without advance notice. Shipments will always adhere to the chromaticity restrictions specified by the order code.
- * Flux values @ 85 °C are calculated and for reference only.
- ** Contact your Cree sales representative for kitted 3-step order code details.

RELATIVE LUMINOUS FLUX VS. CURRENT - JU7070B 12-V K CLASS

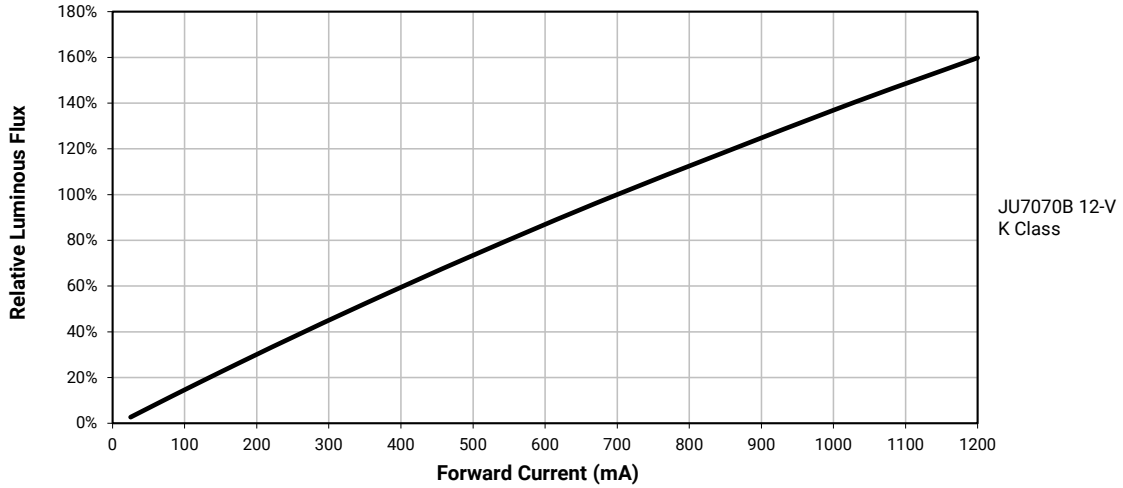

ELECTRICAL CHARACTERISTICS - JU7070B 12-V K CLASS

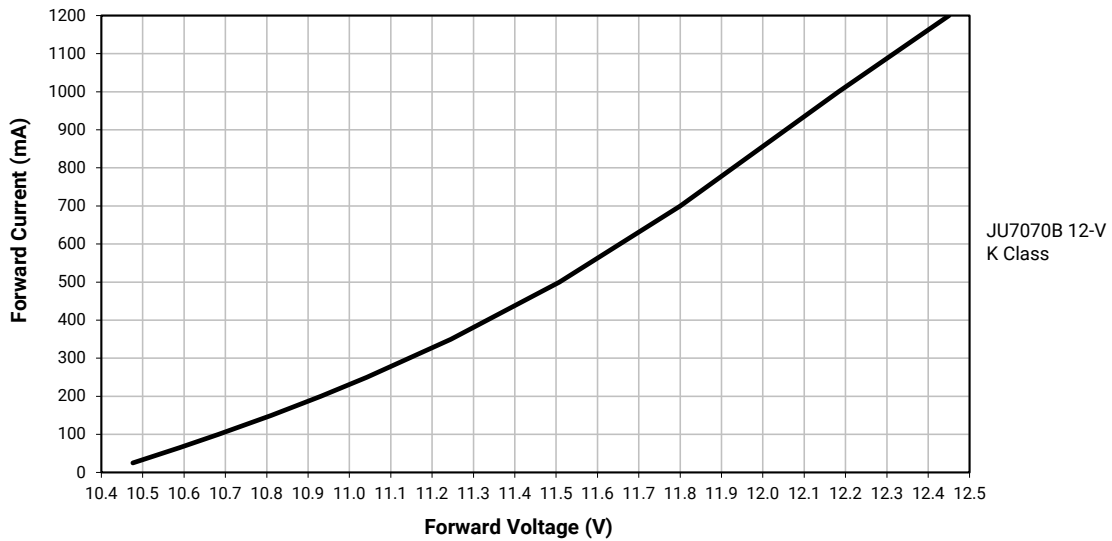

RELATIVE CHROMATICITY VS. CURRENT - JU7070B 12-V K CLASS

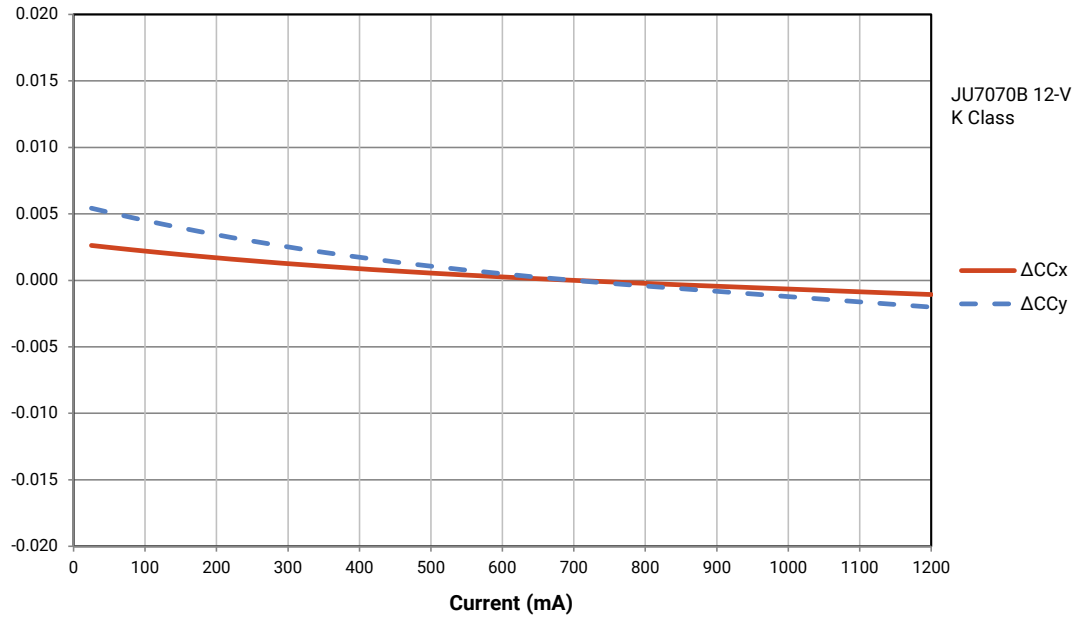

RELATIVE CHROMATICITY VS. JUNCTION TEMPERATURE - JU7070B 12-V K CLASS

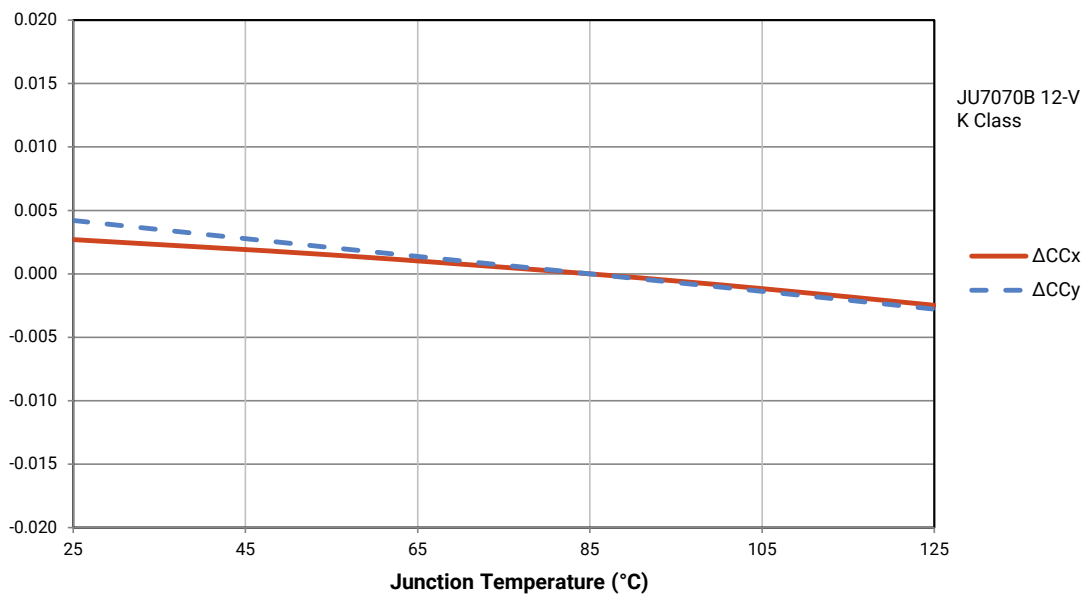

CHARACTERISTICS - JU7070B 36-V K CLASS

Characteristics	Unit	Minimum	Typical	Maximum
Thermal resistance, junction to solder point	°C/W		0.6	
Viewing angle (FWHM)	degrees		115	
Temperature coefficient of voltage	mV/°C		-12.5	
ESD withstand voltage (HBM per Mil-Std-883K)			Class 2	
DC forward current	mA			400
Reverse voltage	V			5
Forward voltage (@ 233 mA, 25 °C)	V		35.4	36.5
LED junction temperature	°C			125
Operating temperature	°C	-40		105

OPERATING LIMITS - JU7070B 36-V K CLASS

The maximum forward current is determined by the thermal resistance between the LED junction and ambient.

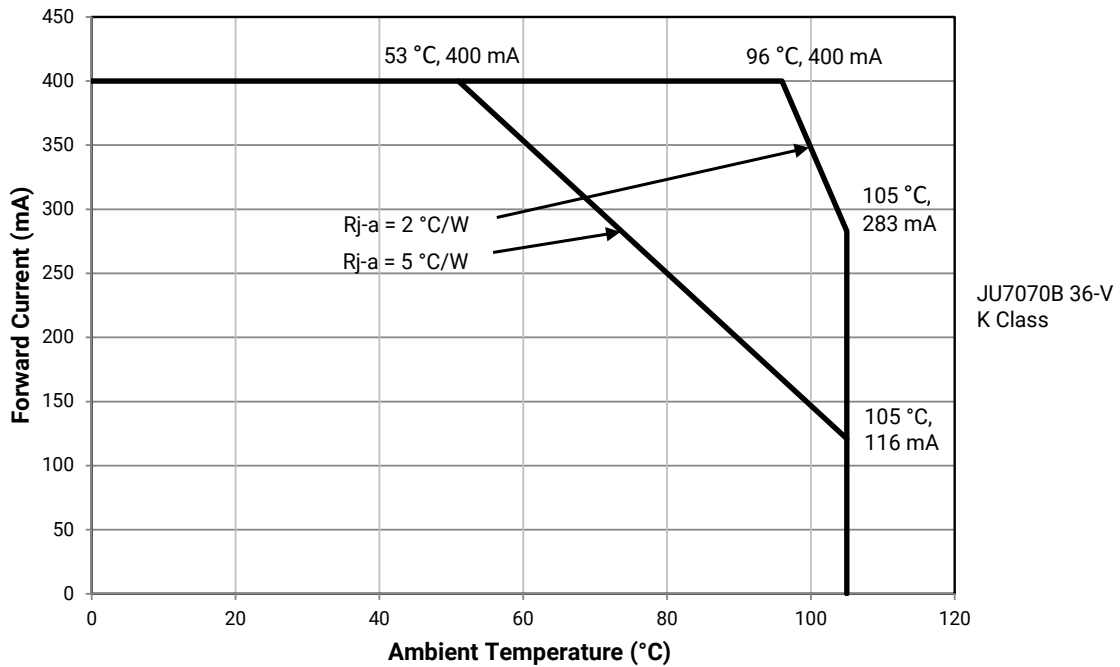

FLUX CHARACTERISTICS, ORDER CODES AND BINS - JU7070B 36-V K CLASS ($I_F = 233 \text{ mA}$, $T_J = 25 \text{ °C}$)

The following table provides order codes for J Series JU7070B 36-V K Class LEDs. For a complete description of the order code nomenclature, please see the Order Code and Bin Code Formats section (page 3). For definitions of the chromaticity kits, please see the Performance Groups - Chromaticity section (page 15).

Nominal CCT	Minimum CRI	Minimum Luminous Flux (lm) @ 25 °C	Typical Luminous Flux (lm) @ 25 °C	Typical Luminous Flux (lm) @ 85 °C*	Kitted 3-Step Order Code**
6500 K	70	1500	1580	1438	JU7070BWT-K-B65EN0000-N0000001
	80	1400	1475	1342	JU7070BWT-K-H65EN0000-N0000001
	90	1250	1320	1201	JU7070BWT-K-U65EN0000-N0000001
5700 K	70	1500	1580	1438	JU7070BWT-K-B57EN0000-N0000001
	80	1400	1475	1342	JU7070BWT-K-H57EN0000-N0000001
	90	1250	1320	1201	JU7070BWT-K-U57EN0000-N0000001
5000 K	70	1500	1580	1438	JU7070BWT-K-B50EN0000-N0000001
	80	1400	1475	1342	JU7070BWT-K-H50EN0000-N0000001
	90	1250	1320	1201	JU7070BWT-K-U50EN0000-N0000001
4000 K	70	1500	1580	1438	JU7070BWT-K-B40EN0000-N0000001
	80	1400	1475	1342	JU7070BWT-K-H40EN0000-N0000001
	90	1250	1320	1201	JU7070BWT-K-U40EN0000-N0000001
3500 K	70	1450	1525	1388	JU7070BWT-K-B35EN0000-N0000001
	80	1350	1418	1290	JU7070BWT-K-H35EN0000-N0000001
	90	1200	1265	1151	JU7070BWT-K-U35EN0000-N0000001
3000 K	70	1400	1495	1360	JU7070BWT-K-B30EN0000-N0000001
	80	1300	1390	1265	JU7070BWT-K-H30EN0000-N0000001
	90	1150	1240	1128	JU7070BWT-K-U30EN0000-N0000001
2700 K	70	1400	1465	1333	JU7070BWT-K-B27EN0000-N0000001
	80	1300	1362	1239	JU7070BWT-K-H27EN0000-N0000001
	90	1100	1200	1092	JU7070BWT-K-U27EN0000-N0000001
2200 K	70	1250	1350	1229	JU7070BWT-K-B22EN0000-N0000001
	80	1150	1228	1117	JU7070BWT-K-H22EN0000-N0000001
	90	1000	1081	984	JU7070BWT-K-U22EN0000-N0000001

Notes:

- Cree Venture maintains a tolerance of $\pm 7\%$ on flux and power measurements, ± 0.005 on chromaticity (CCx, CCy) measurements and ± 2 on CRI measurements. See the Measurements section (page 25).
- Cree Venture J Series JU7070B K Class LED order codes specify only a minimum flux bin and not a maximum. Cree Venture may ship reels in flux bins higher than the minimum specified by the order code without advance notice. Shipments will always adhere to the chromaticity restrictions specified by the order code.
- * Flux values @ 85 °C are calculated and for reference only.
- ** Contact your Cree sales representative for kitted 3-step order code details.

RELATIVE LUMINOUS FLUX VS. CURRENT - JU7070B 36-V K CLASS

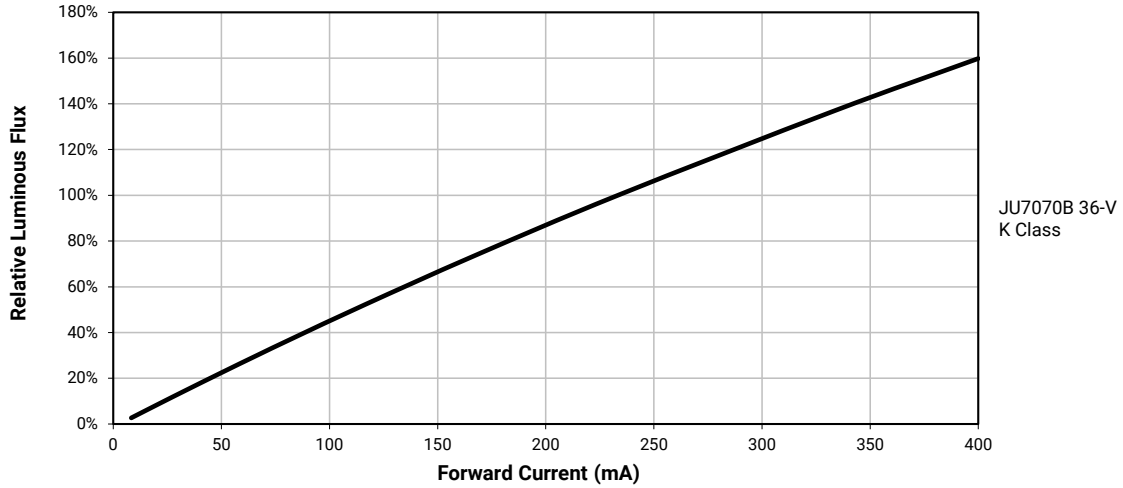

ELECTRICAL CHARACTERISTICS - JU7070B 36-V K CLASS

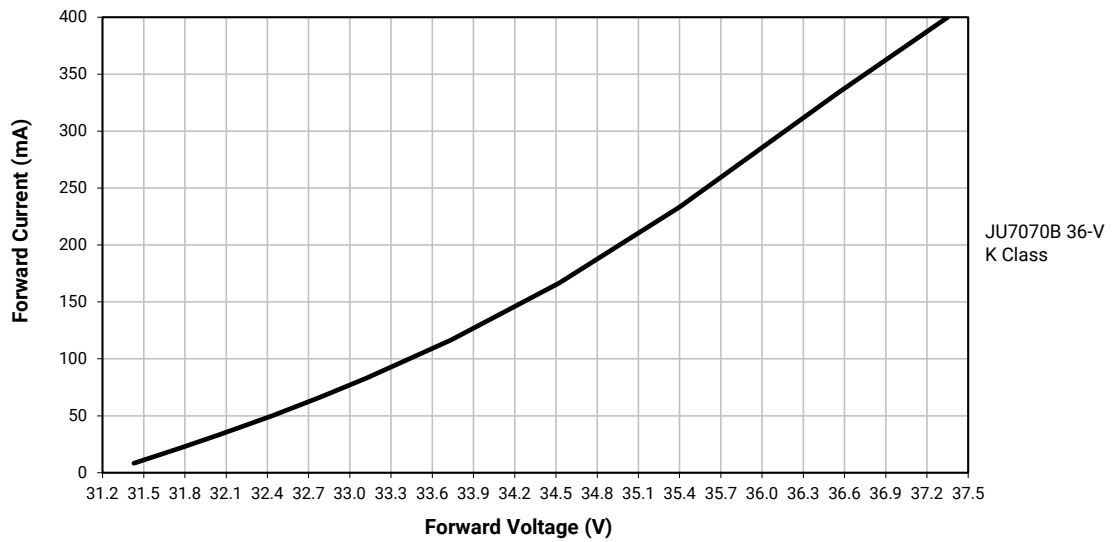

RELATIVE CHROMATICITY VS. CURRENT - JU7070B 36-V K CLASS

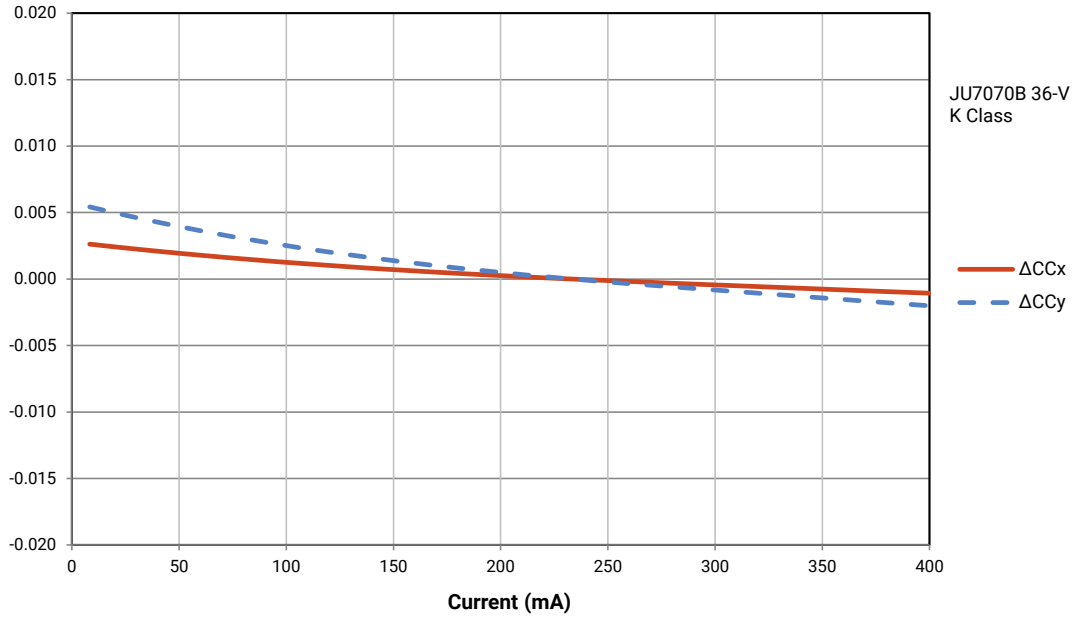

RELATIVE CHROMATICITY VS. JUNCTION TEMPERATURE - JU7070B 36-V K CLASS

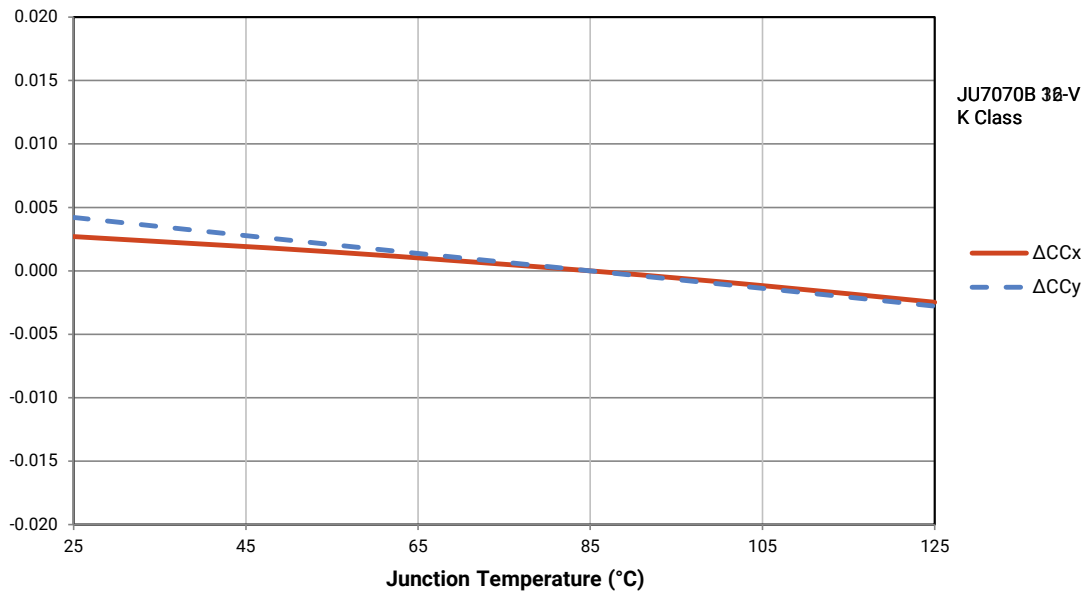

RELATIVE LUMINOUS FLUX VS. JUNCTION TEMPERATURE

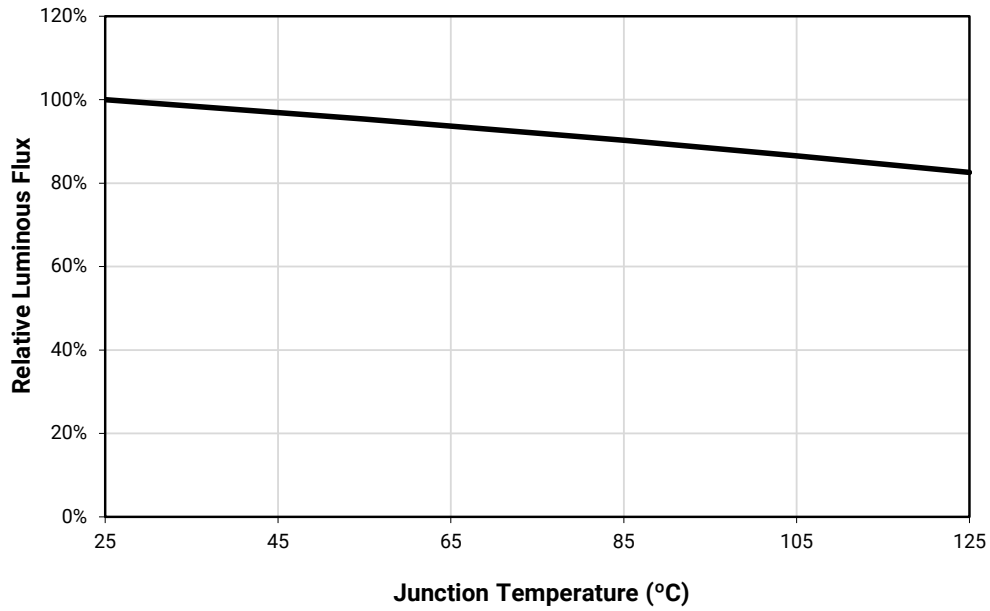

TYPICAL SPATIAL DISTRIBUTION

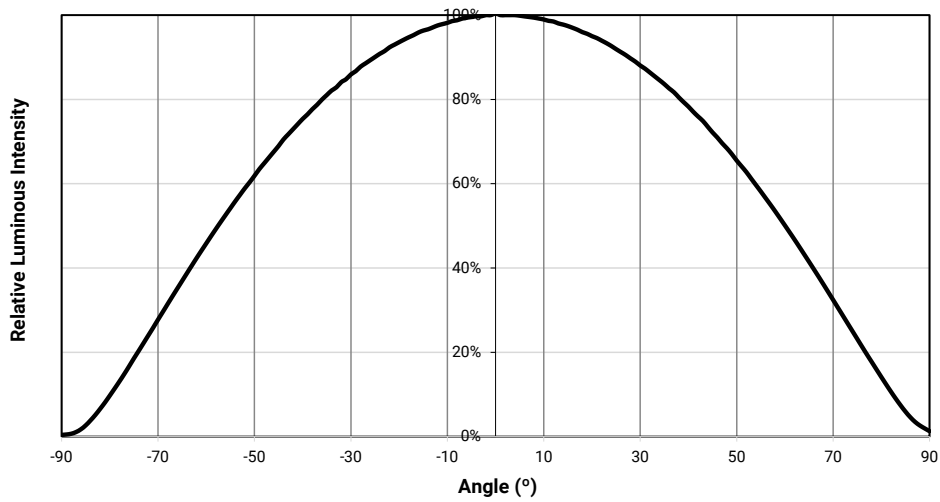

RELATIVE SPECTRAL POWER DISTRIBUTION

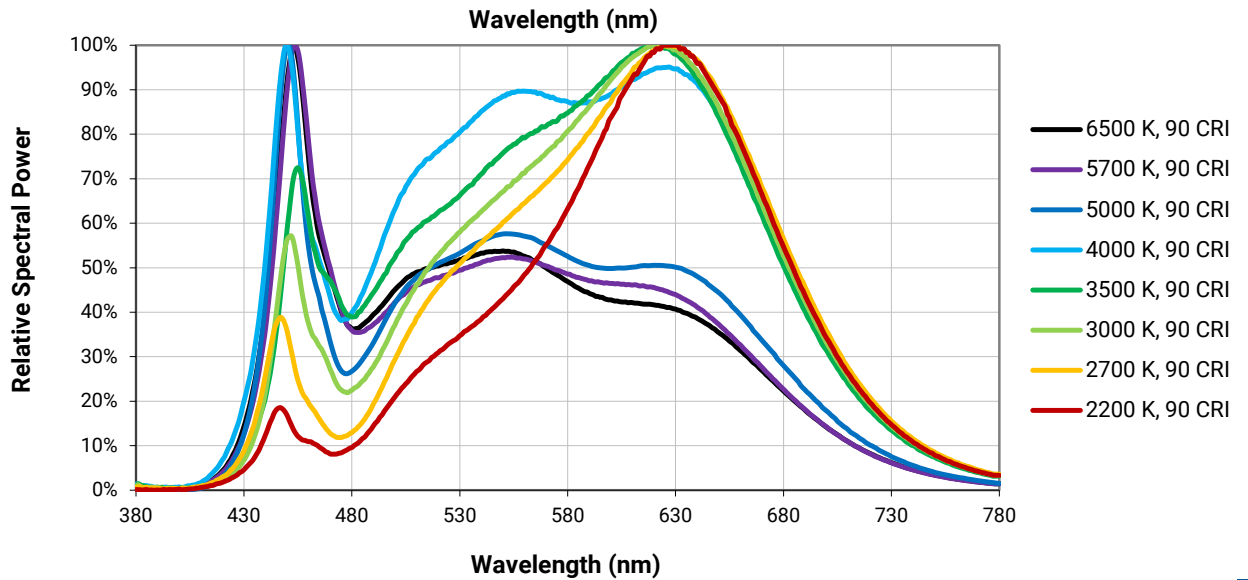
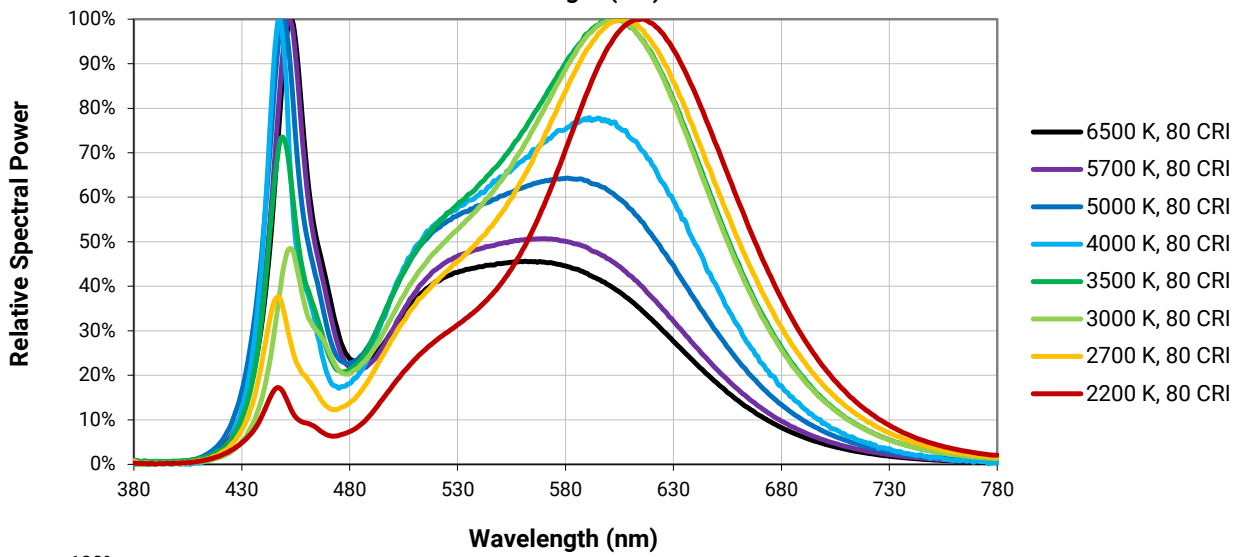
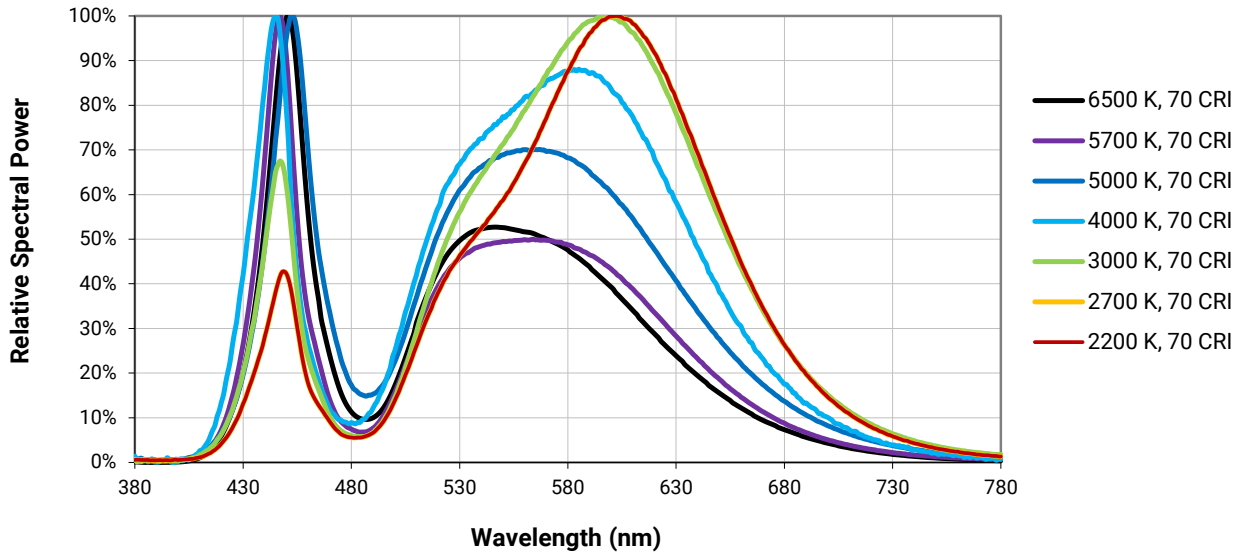

PERFORMANCE GROUPS - LUMINOUS FLUX ($T_j = 25\text{ }^\circ\text{C}$)

J Series JU7070B LEDs are tested for luminous flux at the following current level.

JU7070B LED	Tested For Luminous Flux At
12 V	700 mA
36 V	233 mA

Once tested, J Series JU7070B LEDs are placed into one of the following luminous-flux groups.

Group Code	Minimum Luminous Flux (lm)	Maximum Luminous Flux (lm)
X2	1000	1050
X4	1050	1100
Y2	1100	1150
Y4	1150	1200
P6	1200	1250
P8	1250	1300
Q6	1300	1350
Q8	1350	1400
R6	1400	1450
R8	1450	1500
S6	1500	1550
S8	1550	1600
T6	1600	1650

PERFORMANCE GROUPS - FORWARD VOLTAGE ($T_j = 25\text{ }^\circ\text{C}$)

J Series JU7070B LEDs are tested for forward voltage and placed into one of the following voltage bins.

The following voltage bins are indicated in the Forward Voltage Bin field in the bin code for JU7070B 12-V K Class LEDs.

Voltage Bin	Minimum Forward Voltage (V)	Maximum Forward Voltage (V)
DT	11.0	11.5
DU	11.5	12.0
DV	12.0	12.5

The following voltage bins are indicated in the Forward Voltage Bin field in the bin code for JU7070B 36-V K Class LEDs.

Voltage Bin	Minimum Forward Voltage (V)	Maximum Forward Voltage (V)
NT	35.0	35.5
NU	35.5	36.0
NV	36.0	36.5

PERFORMANCE GROUPS - CHROMATICITY ($T_j = 85\text{ }^\circ\text{C}$)

J Series JU7070B LEDs are tested for chromaticity and placed into one of the regions defined by the following bounding coordinates.

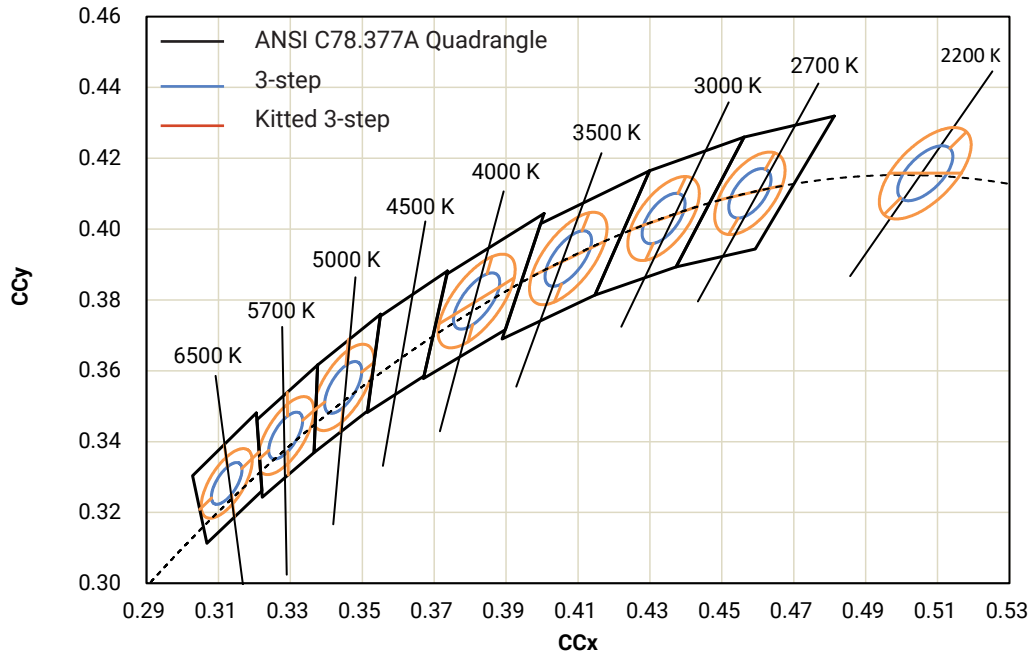

PERFORMANCE GROUPS - CHROMATICITY - CONTINUED ($T_j = 85\text{ }^\circ\text{C}$)

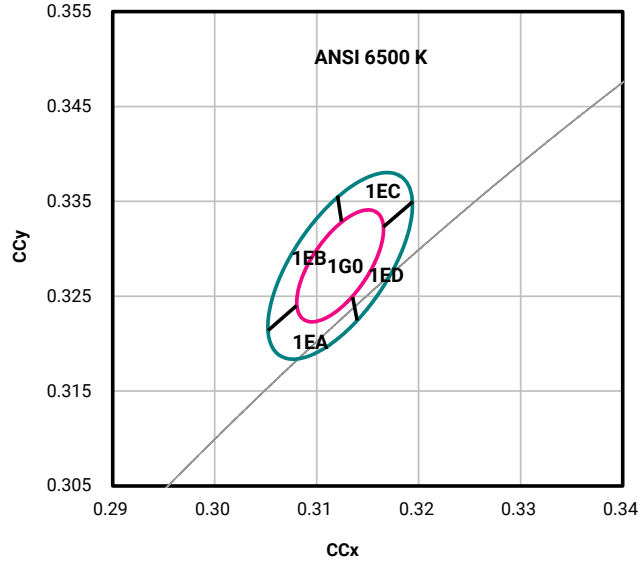

CCT	MacAdam Ellipse	Included Bins	Center Point		Major Axis	Minor Axis	Rotation Angle (°)
			x	y	a	b	
6500 K	3-step	1G0	0.3123	0.3282	0.00669	0.00285	58.57
	Kitted 3-step	1G0, 1EA, 1EB, 1EC, 1ED	0.3123	0.3282	0.01115	0.00475	58.57

PERFORMANCE GROUPS - CHROMATICITY - CONTINUED ($T_j = 85\text{ }^\circ\text{C}$)

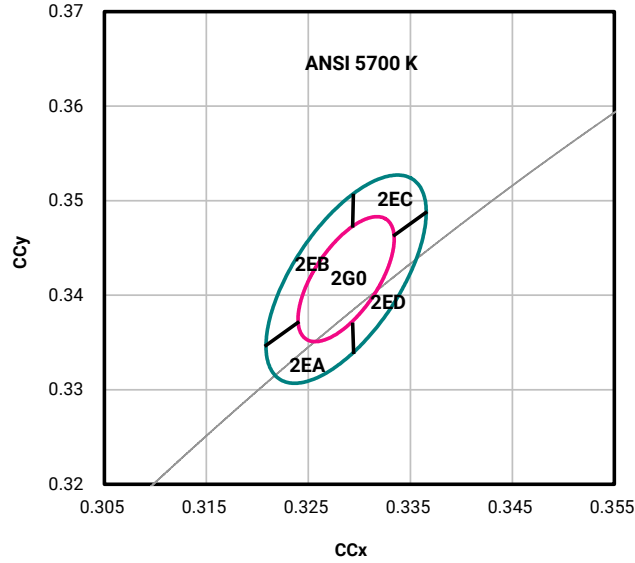

CCT	MacAdam Ellipse	Included Bins	Center Point		Major Axis	Minor Axis	Rotation Angle (°)
			x	y	a	b	
5700 K	3-step	2G0	0.3287	0.3417	0.00746	0.00320	59.09
	Kitted 3-step	2G0, 2EA, 2EB, 2EC, 2ED	0.3287	0.3417	0.01243	0.00533	59.09

PERFORMANCE GROUPS - CHROMATICITY - CONTINUED ($T_j = 85\text{ }^\circ\text{C}$)

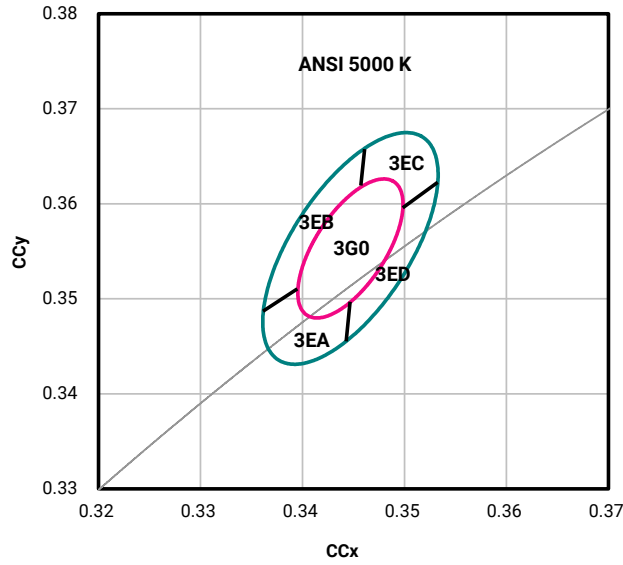

CCT	MacAdam Ellipse	Included Bins	Center Point		Major Axis	Minor Axis	Rotation Angle (°)
			x	y	a	b	
5000 K	3-step	3G0	0.3447	0.3553	0.00822	0.00354	59.62
	Kitted 3-step	3G0, 3EA, 3EB, 3EC, 3ED	0.3447	0.3553	0.01370	0.00590	59.62

PERFORMANCE GROUPS - CHROMATICITY - CONTINUED ($T_j = 85\text{ }^\circ\text{C}$)

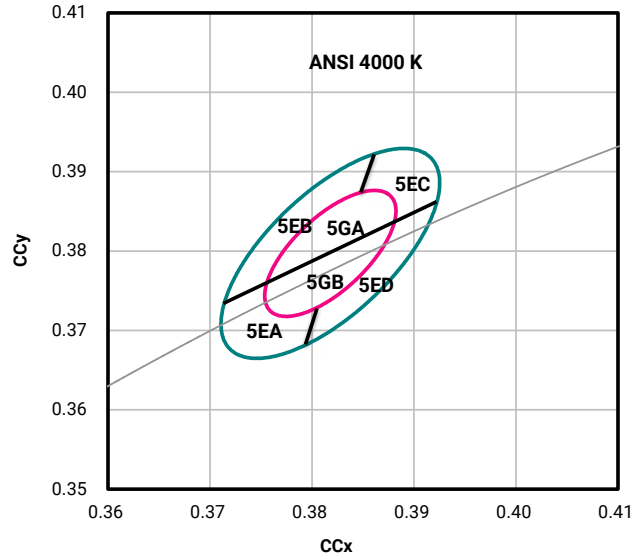

CCT	MacAdam Ellipse	Included Bins	Center Point		Major Axis	Minor Axis	Rotation Angle (°)
			x	y	a	b	
4000 K	3-step	5GA, 5GB	0.3818	0.3797	0.00939	0.00402	53.72
	Kitted 3-step	5GA, 5GB, 5EA, 5EB, 5EC, 5ED	0.3818	0.3797	0.01565	0.00670	53.72

PERFORMANCE GROUPS - CHROMATICITY - CONTINUED ($T_j = 85\text{ }^\circ\text{C}$)

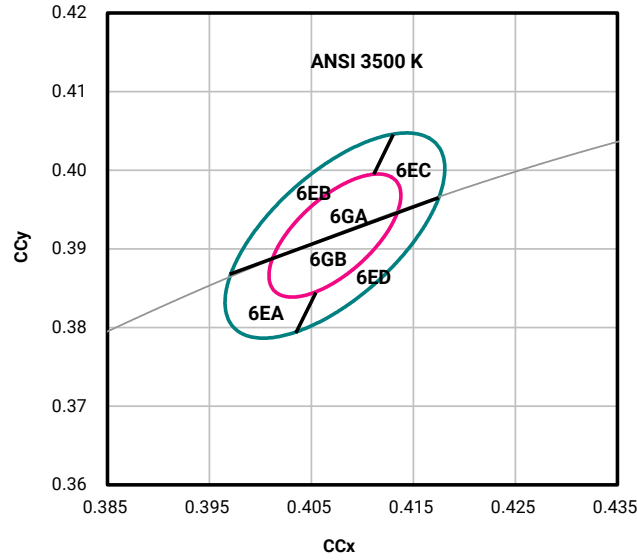

CCT	MacAdam Ellipse	Included Bins	Center Point		Major Axis	Minor Axis	Rotation Angle (°)
			x	y	a	b	
3500 K	3-step	6GA, 6GB	0.4073	0.3917	0.00927	0.00414	54.00
	Kitted 3-step	6GA, 6GB, 6EA, 6EB, 6EC, 6ED	0.4073	0.3917	0.01545	0.00690	54.00

PERFORMANCE GROUPS - CHROMATICITY - CONTINUED ($T_j = 85\text{ }^\circ\text{C}$)

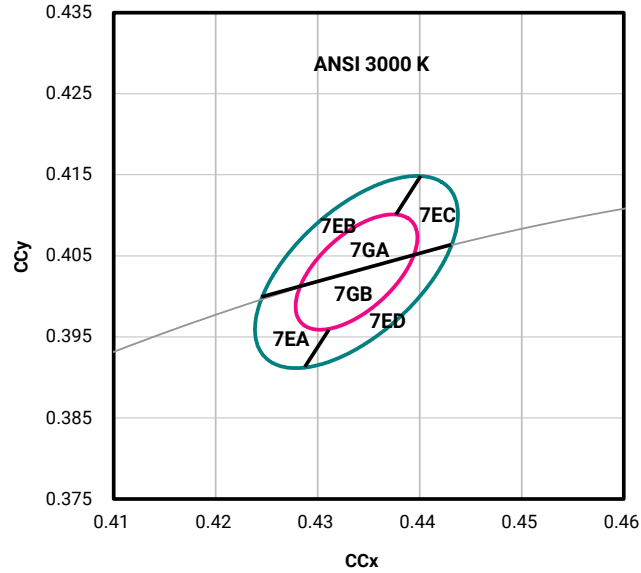

CCT	MacAdam Ellipse	Included Bins	Center Point		Major Axis	Minor Axis	Rotation Angle (°)
			x	y	a	b	
3000 K	3-step	7GA, 7GB	0.4338	0.4030	0.00834	0.00408	53.22
	Kitted 3-step	7GA, 7GB, 7EA, 7EB, 7EC, 7ED	0.4338	0.4030	0.01390	0.00680	53.22

PERFORMANCE GROUPS - CHROMATICITY - CONTINUED ($T_j = 85\text{ }^\circ\text{C}$)

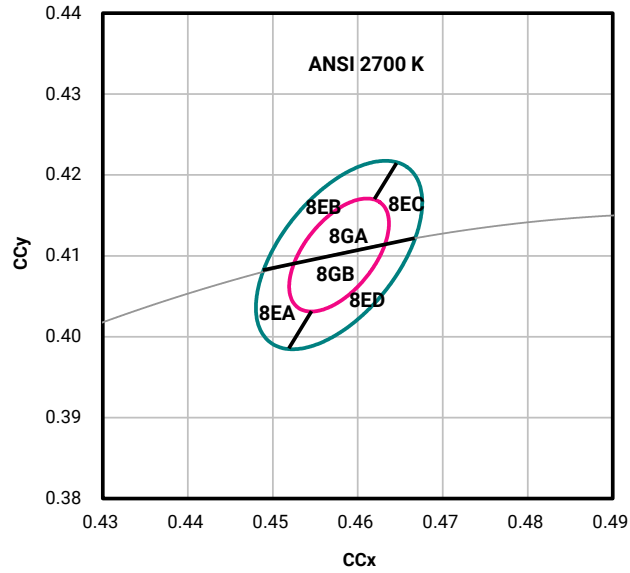

CCT	MacAdam Ellipse	Included Bins	Center Point		Major Axis	Minor Axis	Rotation Angle (°)
			x	y	a	b	
2700 K	3-step	8GA, 8GB	0.4578	0.4101	0.00810	0.00420	53.70
	Kitted 3-step	8GA, 8GB, 8EA, 8EB, 8EC, 8ED	0.4578	0.4101	0.01350	0.00700	53.70

PERFORMANCE GROUPS - CHROMATICITY - CONTINUED ($T_j = 85\text{ }^\circ\text{C}$)

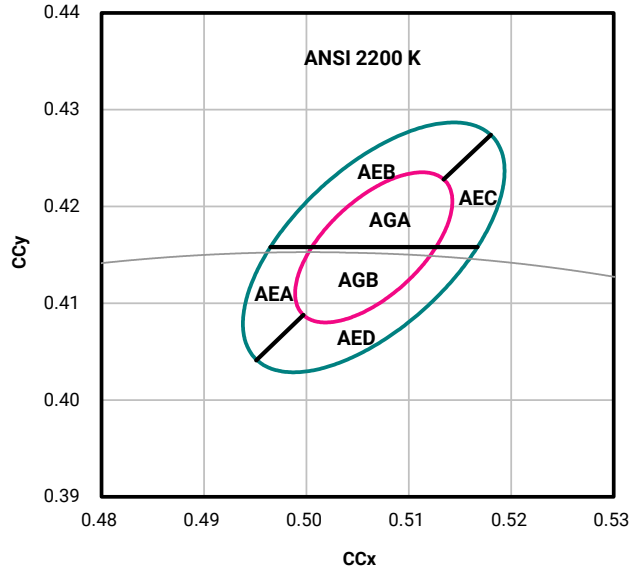

CCT	MacAdam Ellipse	Included Bins	Center Point		Major Axis	Minor Axis	Rotation Angle (°)
			x	y	a	b	
2200 K	3-step	AGA, AGB	0.5066	0.4158	0.0098	0.0048	45.5
	Kitted 3-step	AGA, AGB, AEA, AEB, AEC, AED	0.5066	0.4158	0.0163	0.0080	45.5

REFLOW SOLDERING CHARACTERISTICS

In testing, Cree Venture has found J Series JU7070B K Class LEDs to be compatible with JEDEC J-STD-020C, using the parameters listed below. As a general guideline, Cree Venture recommends that users follow the recommended soldering profile provided by the manufacturer of the solder paste used, and therefore it is the lamp or luminaire manufacturer’s responsibility to determine applicable soldering requirement.

Note that this general guideline may not apply to all PCB designs and configurations of reflow soldering equipment.

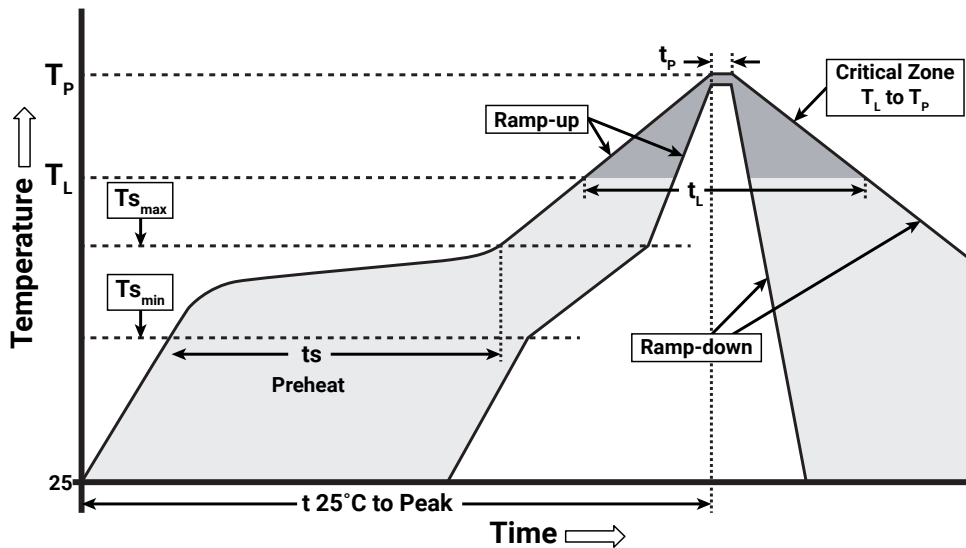

IPC/JEDEC J-STD-020C

Profile Feature	Lead-Free Solder
Average Ramp-Up Rate ($T_{s_{max}}$ to T_P)	1.2 °C/second
Preheat: Temperature Min ($T_{s_{min}}$)	120 °C
Preheat: Temperature Max ($T_{s_{max}}$)	170 °C
Preheat: Time ($t_{s_{min}}$ to $t_{s_{max}}$)	65-150 seconds
Time Maintained Above: Temperature (T_L)	217 °C
Time Maintained Above: Time (t_L)	45-90 seconds
Peak/Classification Temperature (T_P)	235 - 245 °C
Time Within 5 °C of Actual Peak Temperature (t_p)	20-40 seconds
Ramp-Down Rate	1 - 6 °C/second
Time 25 °C to Peak Temperature	4 minutes max.

Note: All temperatures refer to the topline of the package, measured on the package body surface.

NOTES

Measurements

The luminous flux, radiant power, chromaticity, forward voltage and CRI measurements in this document are binning specifications only and solely represent product measurements as of the date of shipment. These measurements will change over time based on a number of factors that are not within Cree Venture’s control and are not intended or provided as operational specifications for the products. Calculated values are provided for informational purposes only and are not intended or provided as specifications.

Pre-Release Qualification Testing

Please read the [J Series Reliability Overview](#) for the details of the pre-release qualification testing for J Series LEDs.

Lumen Maintenance

Cree Venture uses standardized IES LM-80-08 and TM-21-11 methods for collecting long-term data and extrapolating LED lumen maintenance. For information on the specific LM-80 data sets available for this LED, refer to the public [J Series LM-80 results document](#).

Please read the [Thermal Management application note](#) for details on how thermal design, ambient temperature, and drive current affect the LED junction temperature.

Moisture Sensitivity

Cree Venture recommends keeping J Series 7070 LEDs in the provided, resealable moisture-barrier packaging (MBP) until immediately prior to soldering. Unopened MBP that contains J Series 7070 LEDs does not need special storage for moisture sensitivity.

Once the MBP is opened, J Series 7070 LEDs should be handled and stored as MSL 3 per JEDEC J-STD-033, meaning they have limited exposure time before damage to the LED may occur during the soldering operation. The table on the right specifies the maximum exposure time in days depending on temperature and humidity conditions. LEDs with exposure time longer than the specified maximums must be baked according to the baking conditions listed below.

Moisture Sensitivity Level	Temp.	Maximum Percent Relative Humidity				
		50%	60%	70%	80%	90%
Level 3	35 °C	8	5	1	0.5	0.5
Level 3	30 °C	11	7	1	1	1
Level 3	25 °C	14	10	2	1	1
Level 3	20 °C	20	13	2	1	1

Baking Conditions

It is not necessary to bake all J Series 7070 LEDs. Only the LEDs that meet all of the following criteria must be baked:

1. LEDs that have been removed from the original MBP.
2. LEDs that have been exposed to a humid environment longer than listed in the Moisture Sensitivity section above.
3. LEDs that have not been soldered.

LEDs should be baked at 60 °C for 24 hours. LEDs may be baked in the original reels. Remove LEDs from the MBP before baking. Do not bake parts at temperatures higher than 60 °C. This baking operation resets the exposure time as defined in the Moisture Sensitivity section above.

NOTES - CONTINUED

RoHS Compliance

The levels of RoHS restricted materials in this product are below the maximum concentration values (also referred to as the threshold limits) permitted for such substances, or are used in an exempted application, in accordance with EU Directive 2011/65/EC (RoHS2), as implemented January 2, 2013. RoHS Declarations for this product can be obtained from your Cree LED representative or from the [Product Ecology](#) section of the Cree LED website.

REACH Compliance

REACH substances of very high concern (SVHCs) information is available for this product. Since the European Chemical Agency (ECHA) has published notice of their intent to frequently revise the SVHC listing for the foreseeable future, please contact a Cree LED representative to insure you get the most up-to-date REACH SVHC Declaration. REACH banned substance information (REACH Article 67) is also available upon request.

Vision Advisory

WARNING: Do not look at an exposed lamp in operation. Eye injury can result. For more information about LEDs and eye safety, please refer to the [J Series LED Eye Safety application note](#).

MECHANICAL DIMENSIONS

Vias, if present, are not shown on these drawings.

All measurements are ± 0.2 mm unless otherwise indicated.

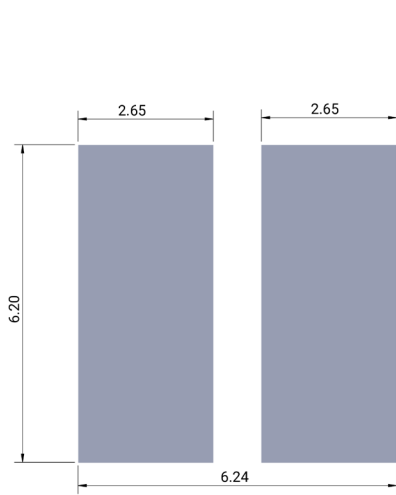
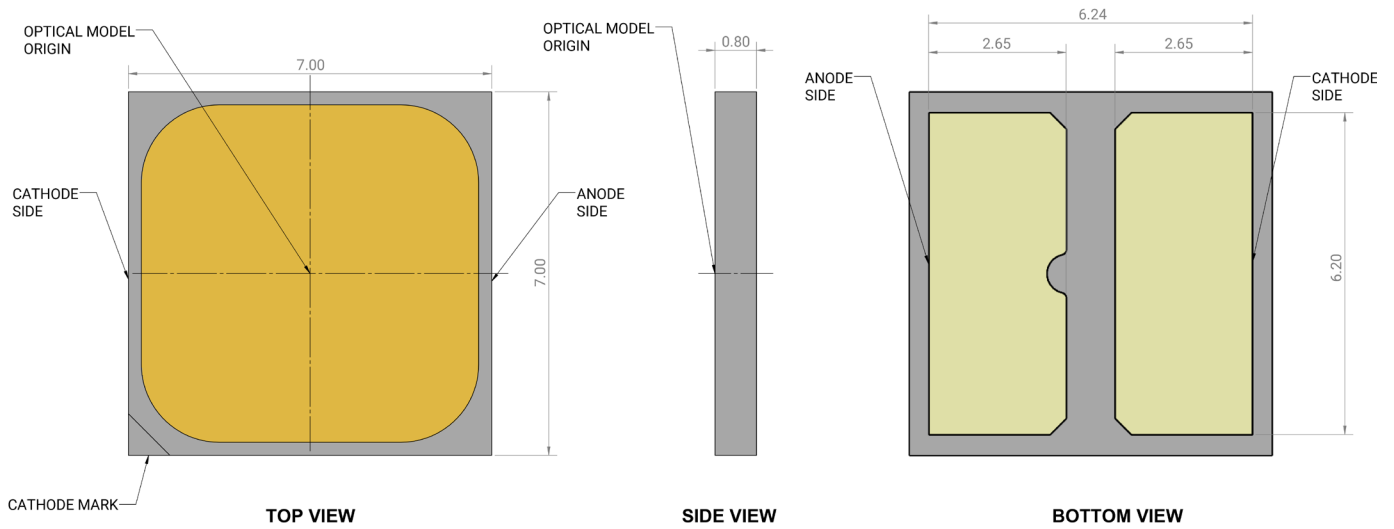

Recommended PCB Footprint

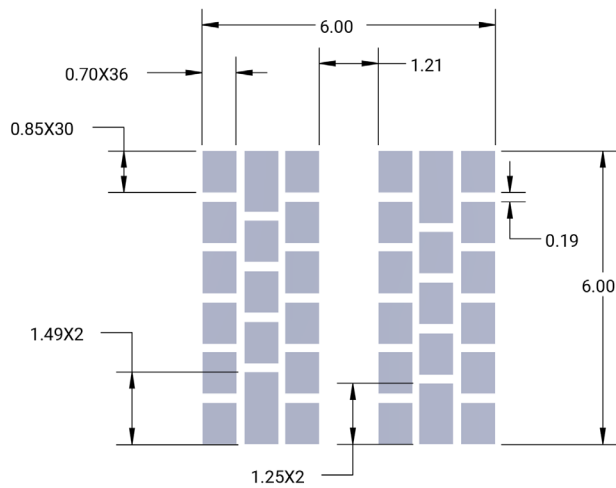

Recommended Stencil Pattern

TAPE & REEL

All Cree Venture carrier tapes conform to EIA-481D, Automated Component Handling Systems Standard.

All dimensions in mm.

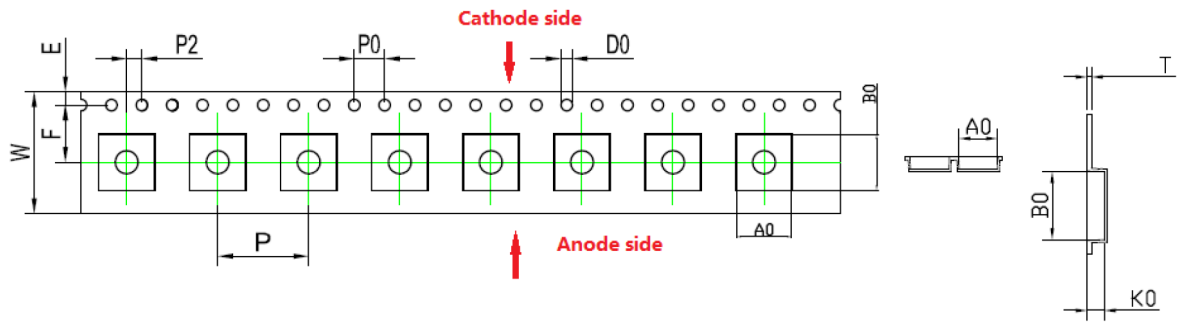

Item	A0	B0	K0	P0	P	P2	W	T	E	F	D0	D1
Dim.	7.30±0.1	7.30±0.1	1.00±0.1	4.00±0.10	12.0±0.1	2.00±0.10	16.0±0.3	0.30±0.05	1.75±0.10	7.5±0.1	1.50 ^{+0.1} ₋₀	1.50±0.10

TAPE & REEL - CONTINUED

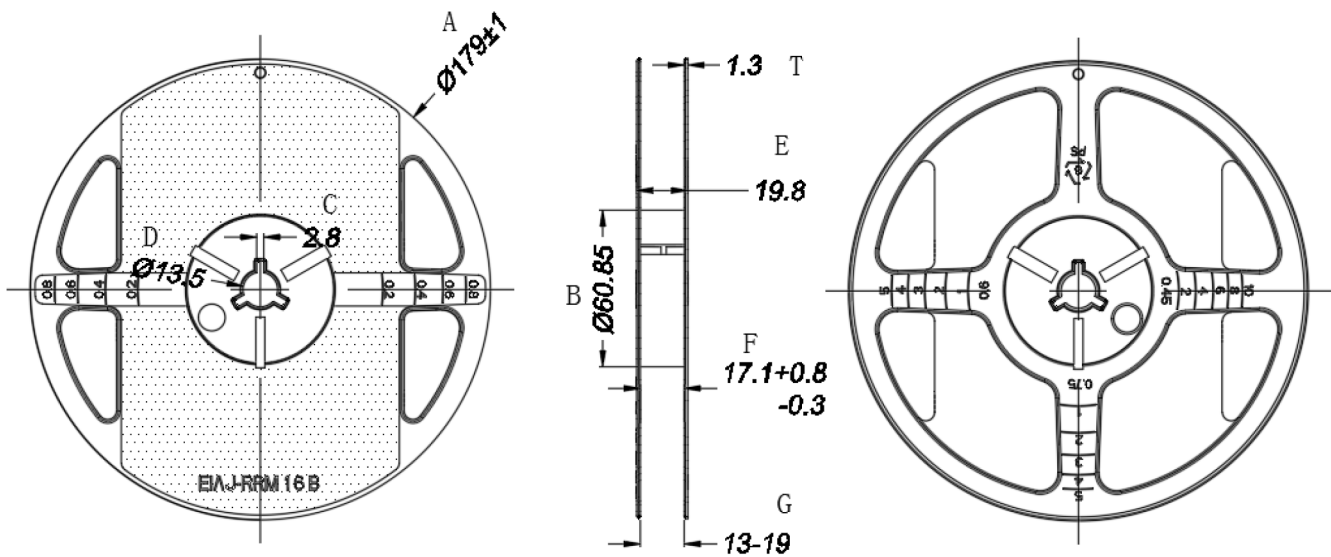
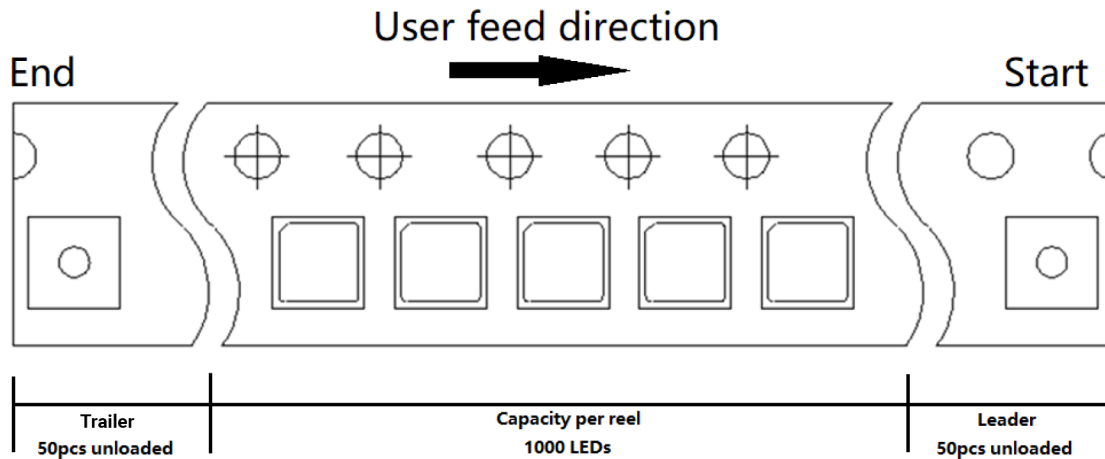

Item	A±1	B±0.5	C±0.3	D±0.3	E±0.5	F ^{+0.8} _{-0.3}	G	T±0.2
Dim.	Ø179	Ø60.85	2.8	Ø13.5	19.8	17.1	13-19	1.3

PACKAGING

Unpackaged Reel

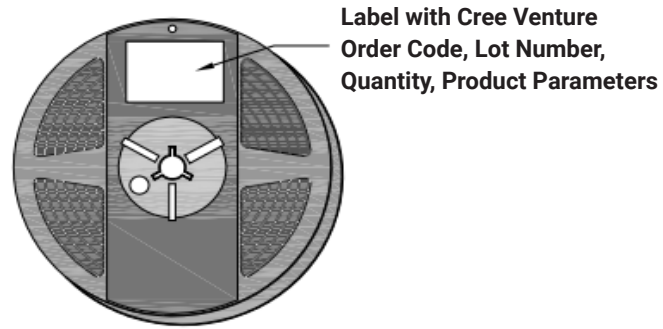

Packaged Reel

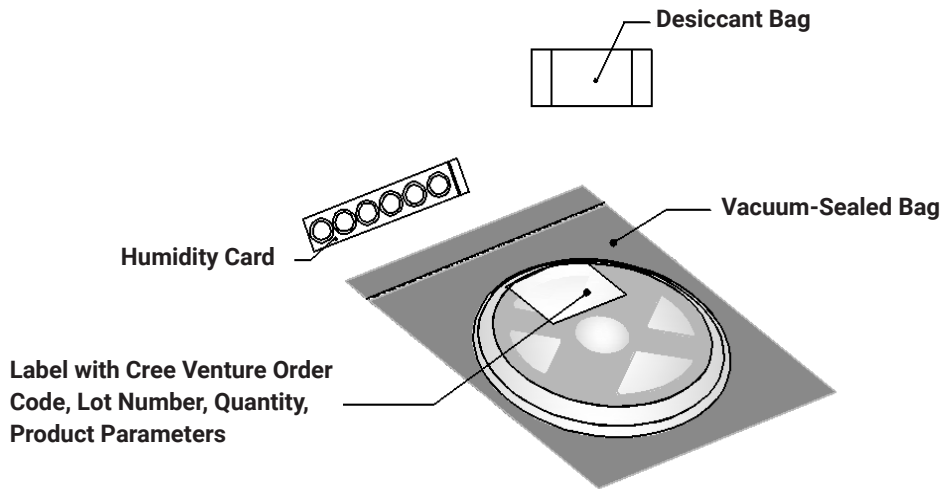

PACKAGING - CONTINUED

J Series 7070 LEDs are packaged in boxes for shipment. Box sizes and the number of reels per box are as follows.

Box	Box Dimensions	Maximum Number of Reels per Box
1	250 x 210 x 30 mm	1
2	250 x 210 x 50 mm	2
3	530 x 230 x 275 mm	28
4	530 x 443 x 275 mm	48

Each box has at least one label (shown as a white square in the diagrams below) showing the order code, lot number, quantity, and product parameters.

Box 1

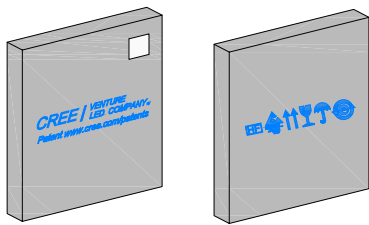

Box 2

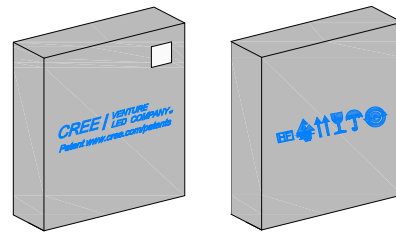

Box 3

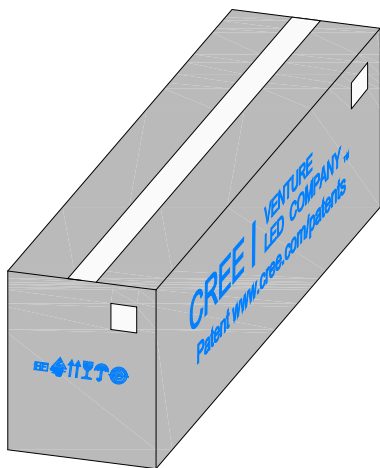

Box 4

