

## CLM6E-FKC: PLCC6 3 in 1 SMD LED

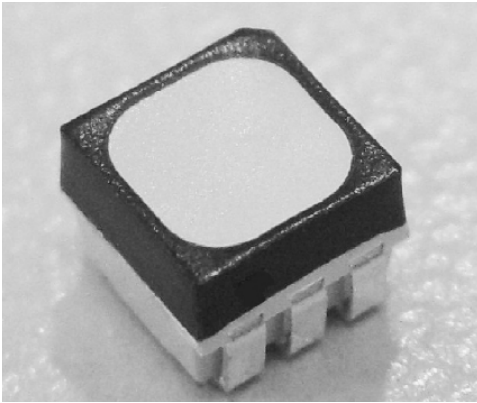

### PRODUCT DESCRIPTION

These high performance tricolor SMT PLCC6 LEDs are designed to work in a wide range of applications. A wide viewing angle and high brightness make these LEDs suitable for architecture lighting and full color signage applications.

### FEATURES

- Size (mm): 3.5 x 3.4 x 2.8
- Dominant Wavelength  
Red (619 - 624nm)  
Green (520 - 535nm)  
Blue (460 - 480nm)
- Luminous Intensity (mcd)  
Red (505 - 1010)  
Green (710 - 1400)  
Blue (180 - 355)
- 
- Moisture Sensitivity Level: 3
- Semi-outdoor
- No water directly touch surface
- Lead-Free
- RoHS Compliant

### APPLICATIONS

- Architecture Lighting
- Decorative Lighting
- Amusement

**ABSOLUTE MAXIMUM RATINGS ( $T_A = 25^\circ\text{C}$ )**

Items	Symbol	Absolute Maximum Rating			Unit
		R	G	B	
Forward Current <sup>Note 1</sup>	$I_F$	50	30	35	mA
Peak Forward Current <sup>Note 2</sup>	$I_{FP}$	200	100	100	mA
Reverse Voltage	$V_R$	5	5	5	V
Power Dissipation	$P_D$	125	105	123	mW
Operation Temperature	$T_{opr}$	-40 ~ +85			$^\circ\text{C}$
Storage Temperature	$T_{stg}$	-40 ~ +100			$^\circ\text{C}$
Junction Temperature	$T_J$	110	110	110	$^\circ\text{C}$
Junction/ambient 1 chip on	$R_{THJA}$	450	400	450	$^\circ\text{C}/\text{W}$
Junction/solder point 1 chip on	$R_{THJs}$	230	230	200	$^\circ\text{C}/\text{W}$
Electrostatic Discharge Classification(MIL-STD-883E)	ESD	1000V			

**Note:**

1. Single-color light
2. Pulse width  $\leq 0.1$  msec, duty  $\leq 1/10$ .

**TYPICAL ELECTRICAL & OPTICAL CHARACTERISTICS ( $T_A = 25^\circ\text{C}$ )**

Characteristics	Condition	Symbol	Values			Unit
			R	G	B	
Dominant Wavelength	$I_F = 15\text{mA(R)}$ $I_F = 10\text{mA(G)}$ $I_F = 10\text{mA(B)}$	$\lambda_{DOM}$	619~624	520~535	460~480	nm
Spectral bandwidth at 50% $I_{REL}$ max	$I_F = 15\text{mA(R)}$ $I_F = 10\text{mA(G)}$ $I_F = 10\text{mA(B)}$	$\Delta \lambda$	24	28	20	nm
Forward Voltage	$I_F = 15\text{mA(R)}$ $I_F = 10\text{mA(G)}$ $I_F = 10\text{mA(B)}$	$V_{F(typ)}$	2.0	2.7	2.7	V
		$V_{F(max)}$	2.5	3.5	3.5	V
Luminous Intensity	$I_F = 15\text{mA(R)}$ $I_F = 10\text{mA(G)}$ $I_F = 10\text{mA(B)}$	$I_{V(min)}$	505	710	180	mcd
		$I_{V(typ)}$	750	1100	270	mcd
Luminous Flux(Reference)	$I_F = 15\text{mA(R)}$ $I_F = 10\text{mA(G)}$ $I_F = 10\text{mA(B)}$	$\Phi_{V(typ)}$	2.1	3.0	0.8	lm
Luminous Intensity(Reference)	$I_F = 20\text{mA(R/G/B)}$	$I_{V(typ)}$	1000	1800	520	mcd
Reverse Current (max)	$V_R = 5\text{V}$	$I_R$	10	10	10	$\mu\text{A}$

\* Continuous reverse voltage can cause LED damage.

## INTENSITY BIN LIMIT

Red (15 mA)			Green (10 mA)			Blue (10 mA)		
Bin Code	Min.(mcd)	Max.(mcd)	Bin Code	Min.(mcd)	Max.(mcd)	Bin Code	Min.(mcd)	Max.(mcd)
km	505	635	M	710	900	E	180	224
K	560	710	qr	805	1010	bc	202	252
np	635	805	N	900	1120	F	224	280
M	710	900	st	1010	1260	de	252	318
qr	805	1010	P	1120	1400	G	280	355

\* Tolerance of measurement of luminous intensity is  $\pm 10\%$ .

## COLOR BIN LIMIT

Red (15 mA)			Green (10 mA)			Blue (10 mA)		
Bin Code	Min.(nm)	Max.(nm)	Bin Code	Min.(nm)	Max.(nm)	Bin Code	Min.(nm)	Max.(nm)
RB	619	624	G7	520	525	B3	460	465
			G23	522.5	527.5	B23	462.5	467.5
			G8	525	530	B4	465	470
			G45	527.5	532.5	B45	467.5	472.5
			G9	530	535	B5	470	475
						B67	472.5	477.5
						B6	475	480

\* Tolerance of measurement of dominant wavelength is  $\pm 1$  nm.

## ORDER CODE TABLE

Kit Number	Color	Luminous Intensity (mcd)		Dominant Wavelength (nm)				Package
		Min.	Max.	Color Bin	Min.(nm)	Color Bin	Max.(nm)	
CLM6E-FKC-CkmqrMPEGBB79363	Red	505	805	RB	619	RB	624	Reel
	Green	710	1400	G7	520	G9	535	Reel
	Blue	180	355	B3	460	B6	480	Reel
CLM6E-FKC-Ckm1M1E1BB7C3D3	Red	Any 1 Intensity bin from km(505) - qr(1010)		RB	619	RB	624	Reel
	Green	Any 1 Intensity bin from M(710) - P(1400)		Any 1 hue bin from G7(520)-G9(535)				Reel
	Blue	Any 1 Intensity bin from E(180) - G(355)		Any 1 hue bin from B3(460)-B6(480)				Reel

### Notes:

- The above kit numbers represent order codes that include multiple intensity-bin and color-bin codes. Only one intensity-bin code and one color-bin code will be shipped on each bulk. Single intensity-bin code and single color-bin codes will not be orderable.
- Please refer to the [HB LED Lamp Reliability Test Standards](#) document for reliability test conditions.
- Please refer to the [HB LED Lamp Soldering & Handling](#) document for information about how to use this LED product safely.

**GRAPHS**

The data below are collected from statistical figures that do not necessarily correspond to the actual parameters of each single LED. Hence, these data will be changed without further notice.

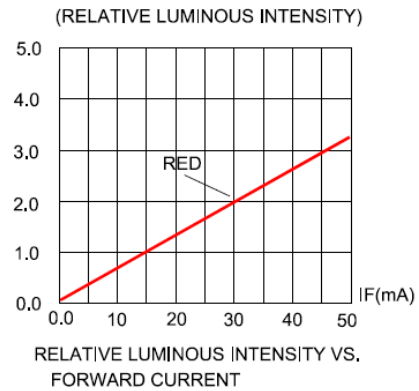
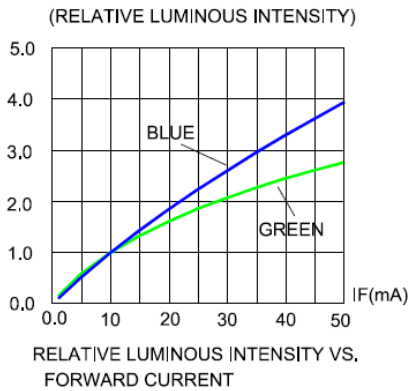
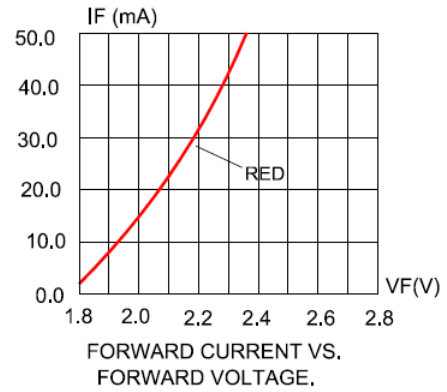
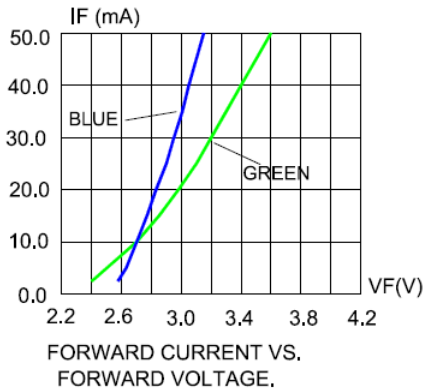
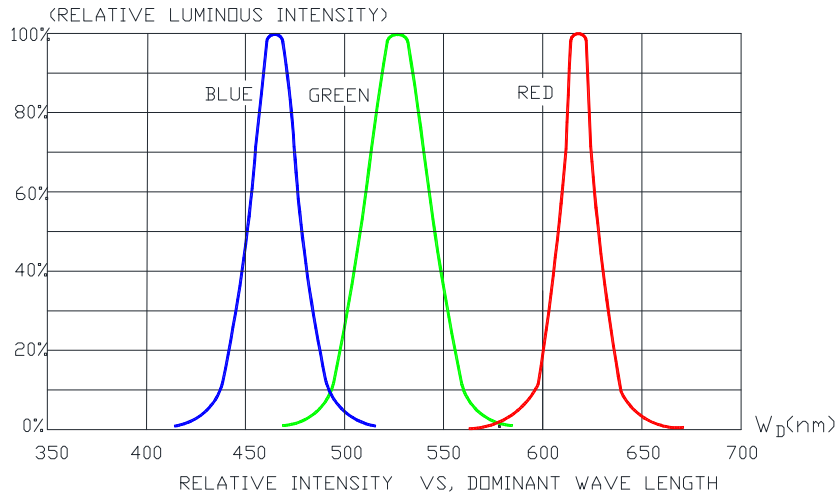

GRAPHS

The data below are collected from statistical figures that do not necessarily correspond to the actual parameters of each single LED. Hence, these data will be changed without further notice.

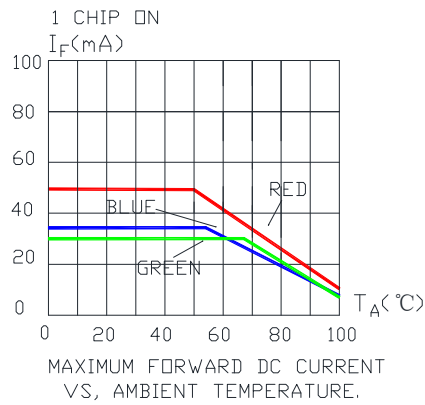
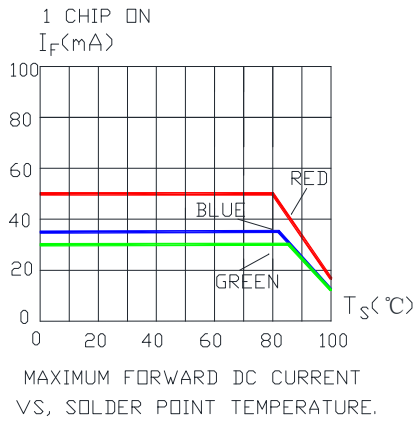
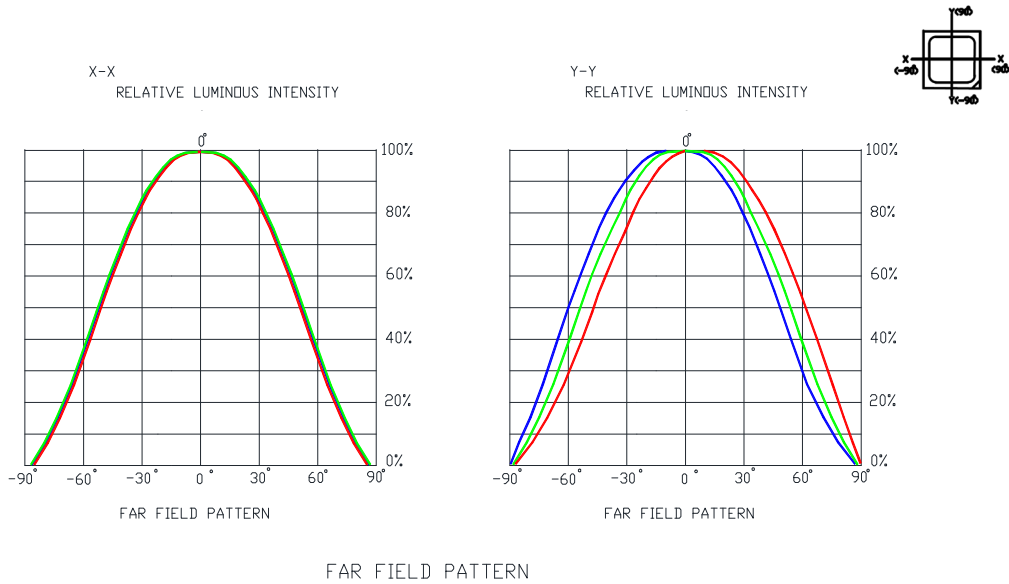

## MECHANICAL DIMENSIONS

All dimensions are in mm.

Tolerance of measurement of the dimension is  $\pm 0.1$ .

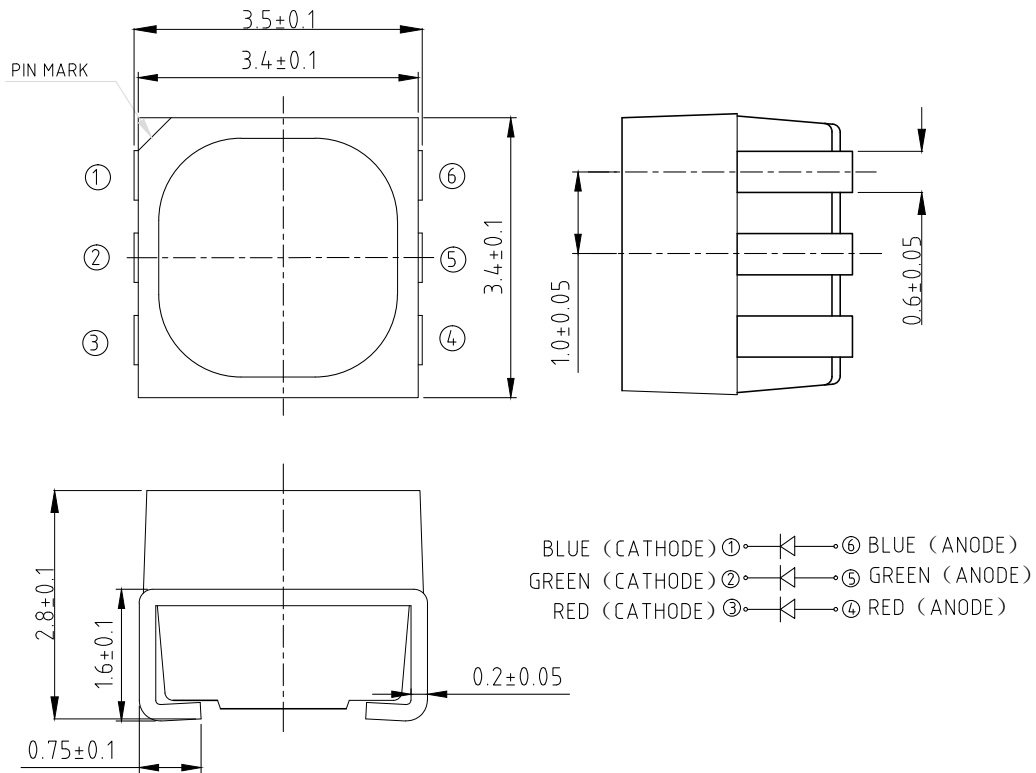

## NOTES

### RoHS Compliance

The levels of RoHS restricted materials in this product are below the maximum concentration values (also referred to as the threshold limits) permitted for such substances, or are used in an exempted application, in accordance with EU Directive 2011/65/EC (RoHS2), as implemented January 2, 2013. RoHS Declarations for this product can be obtained from your Cree LED representative or from the [Product Ecology](#) section of the Cree LED website.

### Vision Advisory

**WARNING:** Do not look at an exposed lamp in operation. Eye injury can result.

**KIT NUMBER SYSTEM**

Cree LED lamps are tested and sorted into performance bins. A bin is specified by ranges of color, forward voltage, and brightness.

Cree LEDs are sold by order codes in combinations of bins called kits. Order codes are configured in the following manner:

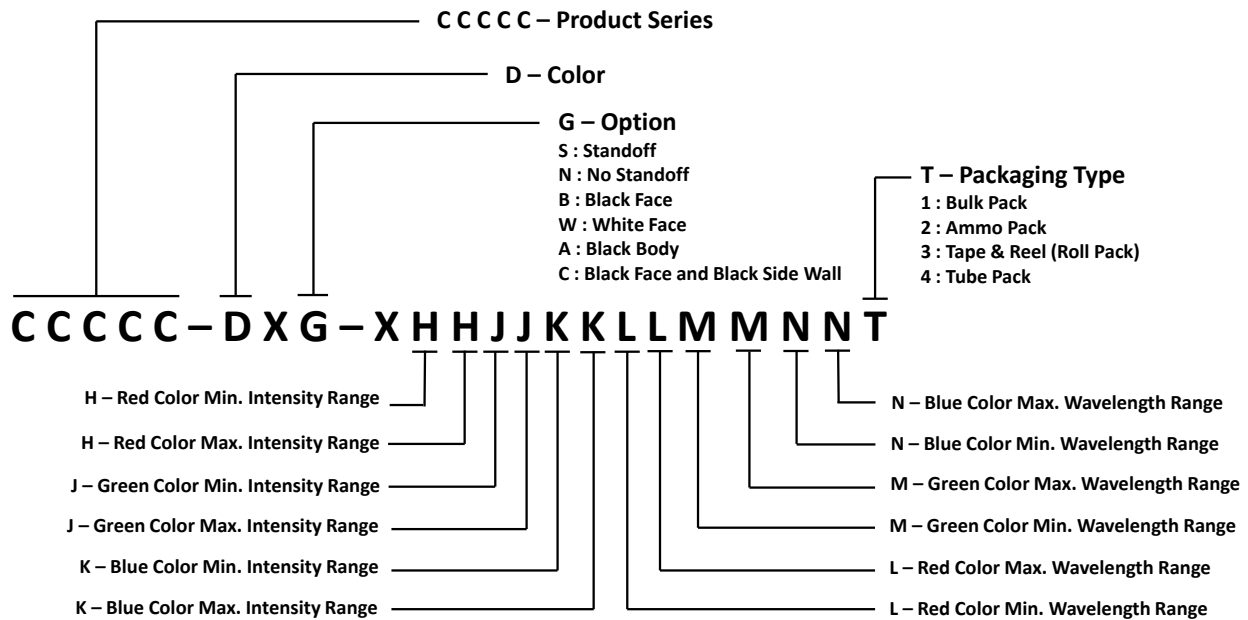



## REFLOW SOLDERING

- The CLM6E-FKC is rated as a MSL 3 product.
- The temperature profile is as below

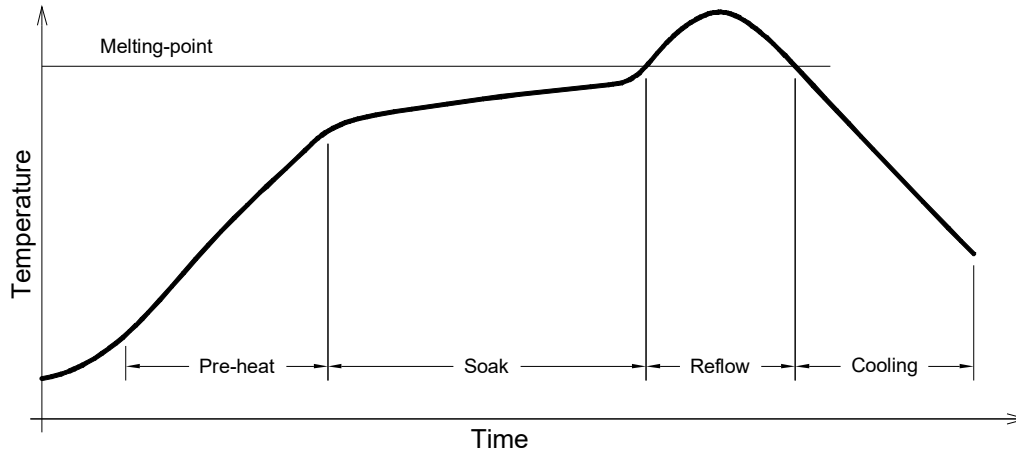

Use only with CLM6E-FKC

Solder
Average ramp-up rate = 4 °C/second max.
Soak temperature = 150°C-200°C
Soak time = 120 seconds max.
Duration above 217 °C = 60 seconds max.
Peak temperature = 250°C max
Time within 5 °C of peak temperature = 10 seconds max.
Ramp-down rate = 6 °C/second max.

## NOTES

- The packaging sizes of these SMD products are very small and the resin is still soft after solidification. Users are required to handle with care. Never touch the resin surface of SMD products.
- To avoid damaging the product's surface and interior device, it is recommended to choose a special nozzle to pick up the SMD products during the process of SMT production. If handling is necessary, take special care when picking up these products. The following method is necessary:

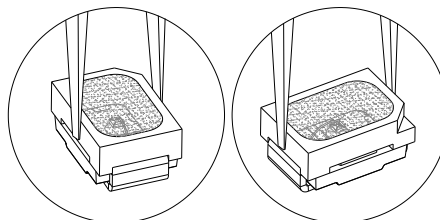

## PACKAGING

- The boxes are not water resistant and they must be kept away from water and moisture.
- The LEDs are packed in cardboard boxes after packaging in normal or anti-electrostatic bags.
- Cardboard boxes will be used to protect the LEDs from mechanical shocks during transportation.
- The reel pack is applied in SMD LED.
- Max 2800 pcs per reel.

