

CLM2D-CCC: PLCC4 Cyan SMD LEDs



PRODUCT DESCRIPTION

SMD LEDs is packaged in the industry standard package. These LEDs have high reliability performance and are designed to work under a wide range of environmental conditions. This high reliability feature makes them ideally suited to be used in architectural lighting application conditions

Cree LED has been certified in accordance with ISO/IATF16949.

FEATURES

- Size (mm): 3.2 x 2.8
- Color and Typical Dominant Wavelength:
Gyan (500-512.5nm)
- Moisture Sensitivity Level: 5a
- Lead - Free
- RoHS Compliant
- Untinted Diffused Lens

APPLICATIONS

- Channel Letter
- Architectural Lighting

ABSOLUTE MAXIMUM RATINGS ($T_A = 25^\circ\text{C}$)

| Items | Symbol | Absolute Maximum Rating | Unit |
|--|------------|-------------------------|---------------------------|
| Forward Current | I_F | 35 | mA |
| Peak Forward Current ^{Note1} | I_{FP} | 100 | mA |
| Reverse Voltage | V_R | 5 | V |
| Power Dissipation | P_D | 140 | mW |
| Operation Temperature | T_{opr} | -40 ~ +100 | $^\circ\text{C}$ |
| Storage Temperature | T_{stg} | -40 ~ +100 | $^\circ\text{C}$ |
| Junction Temperature | T_J | 110 | $^\circ\text{C}$ |
| Junction/Ambient | R_{THJA} | 400 | $^\circ\text{C}/\text{W}$ |
| Junction/Solder Point | R_{THJS} | 180 | $^\circ\text{C}/\text{W}$ |
| Electrostatic Discharge Classification(MIL-STD-883E) | ESD | 1000V | |

Note:

1. Pulse width ≤ 0.1 msec, duty $\leq 1/10$.

TYPICAL ELECTRICAL & OPTICAL CHARACTERISTICS ($T_A = 25^\circ\text{C}$)

| Characteristics | Symbol | Condition | Unit | Minimum | Typical | Maximum |
|---------------------|-------------|---------------|---------------|---------|---------|---------|
| Forward Voltage | V_F | $I_F = 20$ mA | V | | 3.2 | 4.0 |
| Reverse Current | I_R | $V_R = 5$ V | μA | | | 10 |
| Dominant Wavelength | λ_D | $I_F = 20$ mA | nm | 500 | 506 | 512.5 |
| Luminous Intensity | I_V | $I_F = 20$ mA | mcd | 3550 | 6500 | |

- * Continuous reverse voltage can cause LED damage.

INTENSITY BIN LIMIT

| Gyan (20 mA) | | |
|--------------|-----------|-----------|
| Bin Code | Min.(mcd) | Max.(mcd) |
| Yb | 3550 | 4500 |
| Z0 | 4500 | 5600 |
| A0 | 5600 | 7100 |
| B0 | 7100 | 9000 |
| C0 | 9000 | 11200 |

* Tolerance of measurement of luminous intensity is $\pm 10\%$

COLOR BIN LIMIT

| Gyan (20 mA) | | |
|--------------|----------|----------|
| Bin Code | Min.(nm) | Max.(nm) |
| G3 | 500 | 505 |
| G01 | 502.5 | 507.5 |
| G4 | 505 | 510 |
| G12 | 507.5 | 512.5 |

* Tolerance of measurement of dominant wavelength is ± 1 nm.

ORDER CODE TABLE

| Color | Kit Number | Luminous Intensity (mcd) | | Dominant Wavelength | | | | Package |
|-------|---------------------|--------------------------|-------|---------------------|----------|-----------|----------|---------|
| | | Min. | Max. | Color Bin | Min.(nm) | Color Bin | Max.(nm) | |
| Gyan | CLM2D-CCC-CYbC03123 | 3550 | 11200 | G3 | 500 | G12 | 512.5 | Reel |
| | CLM2D-CCC-CZ0C03123 | 4500 | 11200 | G3 | 500 | G12 | 512.5 | Reel |
| | CLM2D-CCC-CZ0C0343 | 4500 | 11200 | G3 | 500 | G4 | 510 | Reel |

Notes:

- The above kit numbers represent order codes that include multiple intensity-bin and color-bin codes. Only one intensity-bin code and one color-bin code will be shipped on each bulk. Single intensity-bin code and single color-bin codes will not be orderable.
- Please refer to the [HB LED Lamp Reliability Test Standards](#) document for reliability test conditions.
- Please refer to the [HB LED Lamp Soldering & Handling](#) document for information about how to use this LED product safely.

GRAPHS

The data below are collected from statistical figures that do not necessarily correspond to the actual parameters of each single LED. Hence, these data will be changed without further notice.

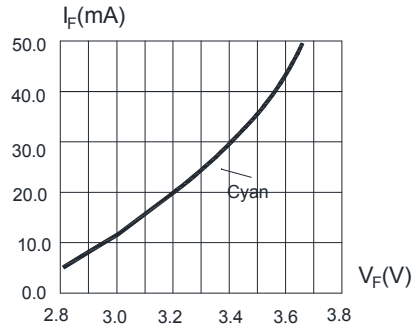

FIG.1 FORWARD CURRENT VS. FORWARD VOLTAGE.

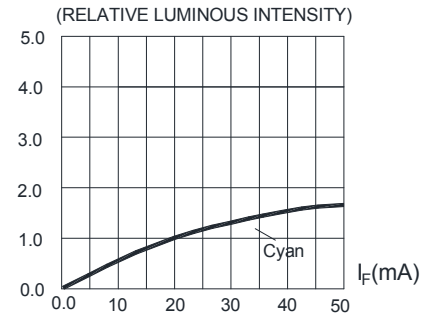

FIG.2 RELATIVE LUMINOUS INTENSITY VS. FORWARD CURRENT

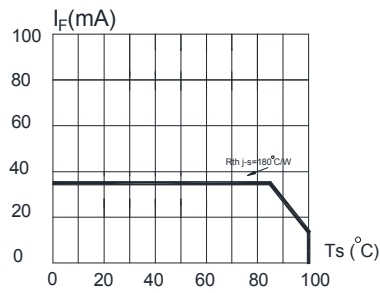

FIG.3 MAXIMUM FORWARD DC CURRENT VS SOLDER TEMPERATURE ($T_{jmax}=110^{\circ}C$)

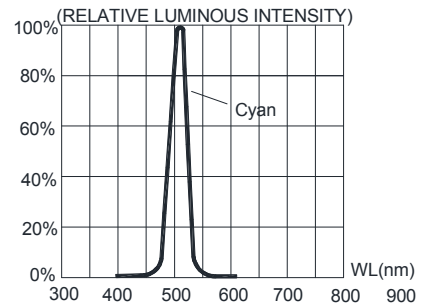

FIG.4 RELATIVE LUMINOUS INTENSITY VS. WAVELENGTH.

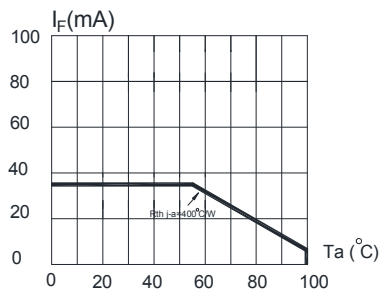

FIG.5 MAXIMUM FORWARD DC CURRENT VS AMBIENT TEMPERATURE ($T_{jmax}=110^{\circ}C$)

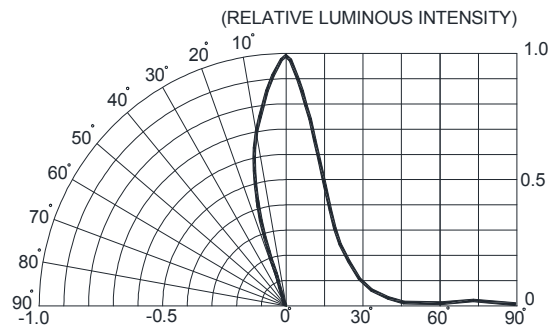
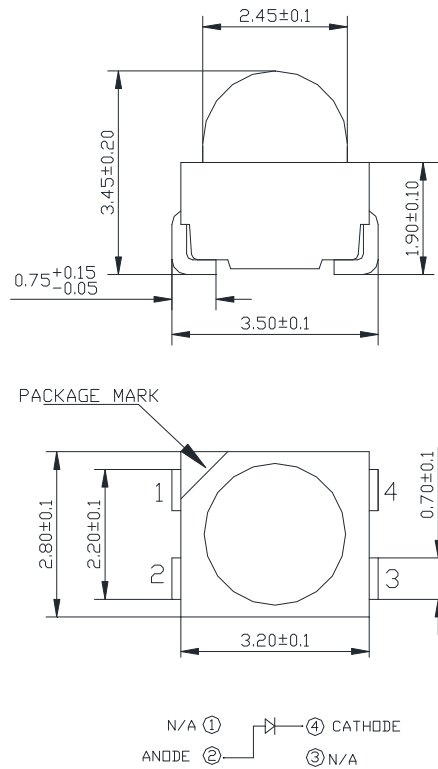

FIG.6 FAR FIELD PATTERN

MECHANICAL DIMENSIONS

All dimensions are in mm.



NOTES

RoHS Compliance

The levels of RoHS restricted materials in this product are below the maximum concentration values (also referred to as the threshold limits) permitted for such substances, or are used in an exempted application, in accordance with EU Directive 2011/65/EC (RoHS2), as implemented January 2, 2013. RoHS Declarations for this product can be obtained from your Cree LED representative or from the [Product Ecology](#) section of the Cree LED website.

Vision Advisory

WARNING: Do not look at an exposed lamp in operation. Eye injury can result.

KIT NUMBER SYSTEM

Cree LED lamps are tested and sorted into performance bins. A bin is specified by ranges of color, forward voltage, and brightness. Sorted LEDs are packaged for shipping in various convenient options.

Cree LEDs are sold by order codes in combinations of bins called kits. Order codes are configured in the following manner:

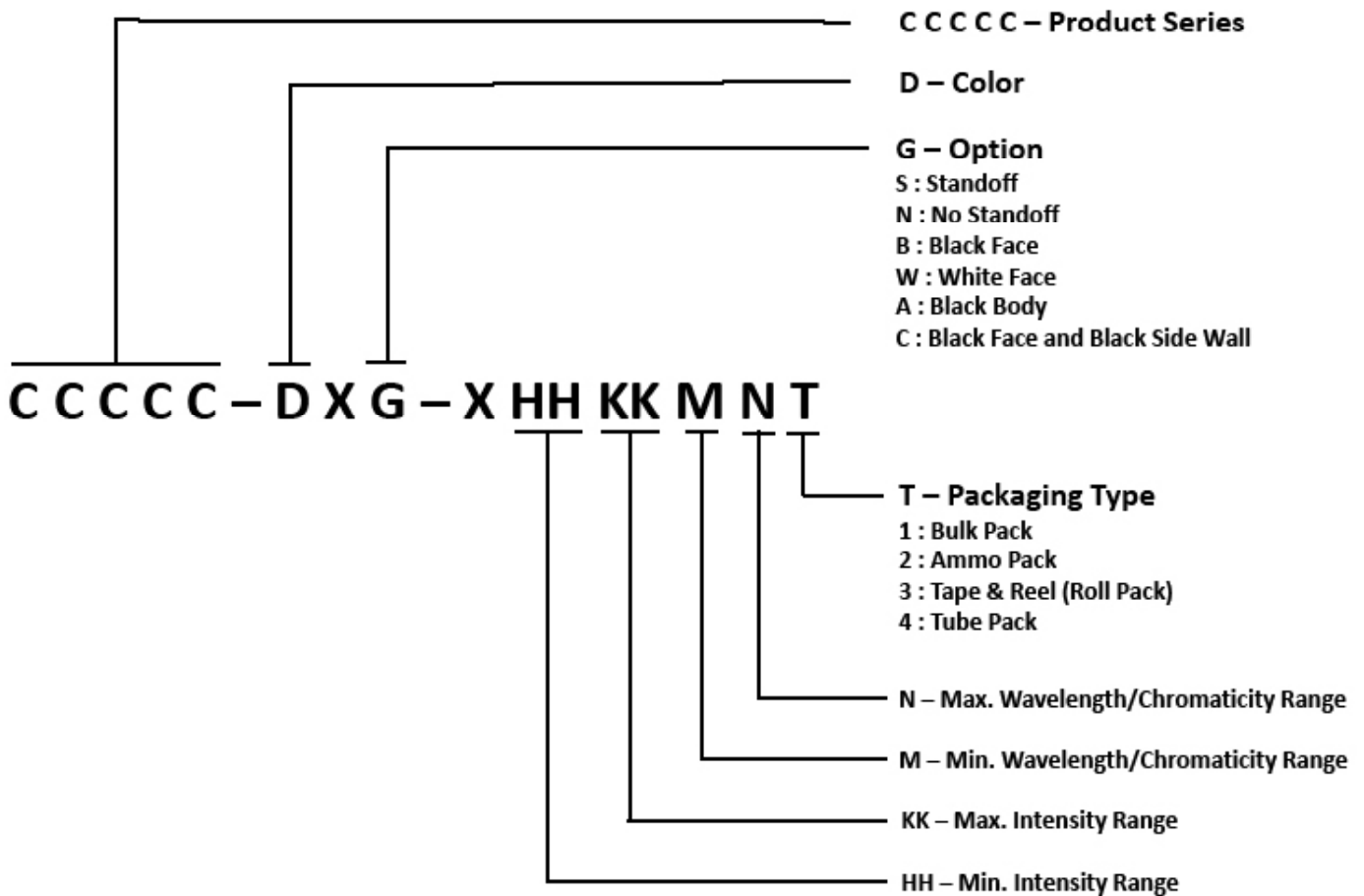

REFLOW SOLDERING

- The CLM2D-CCC is rated as a MSL 5a product.
- The recommended floor life out of bag is 24hrs.
- The temperature profile is as below.

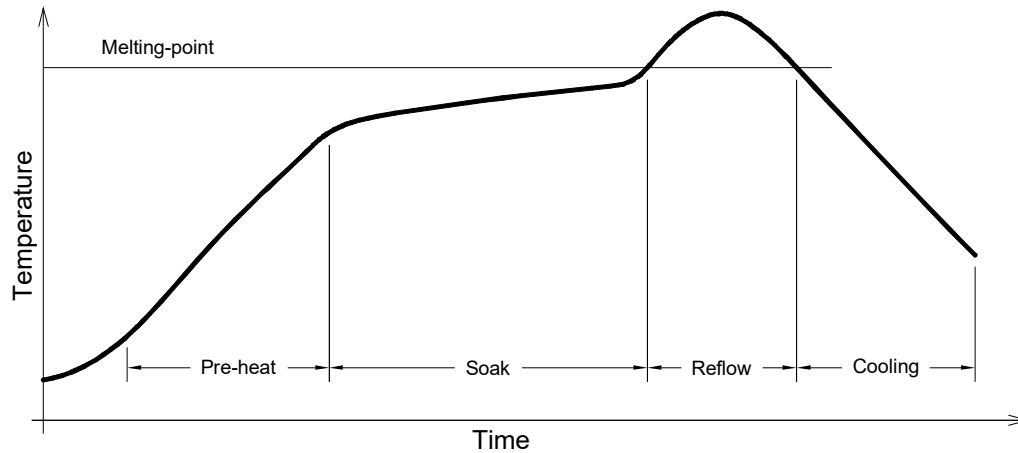

Use only with CLM2D-CCC

| Solder |
|--|
| Average ramp-up rate = 4 °C/second max. |
| Soak temperature = 150°C-200°C |
| Soak time = 120 seconds max. |
| Duration above 217 °C = 60 seconds max. |
| Peak temperature = 250°C max |
| Time within 5 °C of peak temperature = 10 seconds max. |
| Ramp-down rate = 6 °C/second max. |

- The packaging sizes of these SMD products are very small and the resin is still soft after solidification. Users are required to handle with care. Never touch the resin surface of SMD products.
- To avoid damaging the product's surface and interior device, it is recommended to choose a special nozzle to pick up the SMD products during the process of SMT production. If handling is necessary, take special care when picking up these products. The following method is necessary:
- Please refer to the [HB LED Lamp Soldering & Handling](#) document for information about how to use this LED product safely.

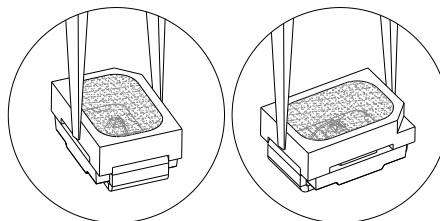

PACKAGING

- The LEDs are packed in cardboard boxes after packaging in normal or anti-electrostatic bags.
- Cardboard boxes will be used to protect the LEDs from mechanical shock during transportation.
- The boxes are not water resistant, and they must be kept away from water and moisture.
- The reel pack is applied in SMD LED.
- Max 2300 pcs per reel.

